

## ■ Head profile Double C-profile 45/52 Height 52 mm Elongated hole 17,5x13 mm

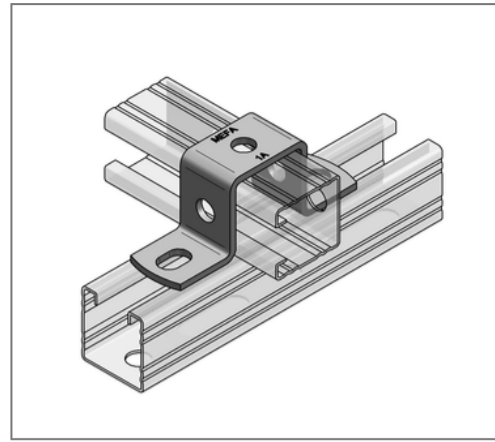
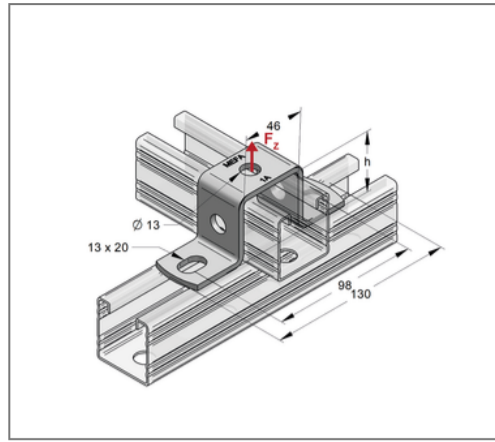
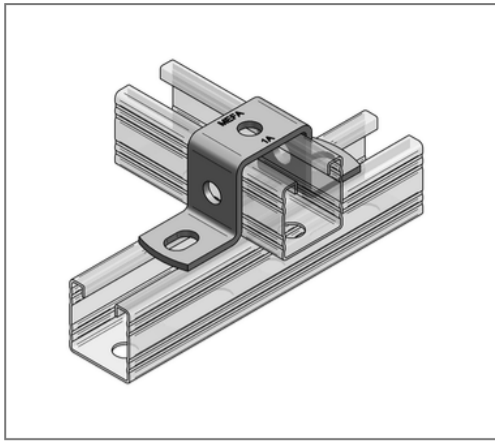

### Commercial details

Part no.	08162452
EAN/GTIN	4250928420237
Packing unit	25 pcs
Quantity unit	pcs
Weight	0,235 kg/pc
Product group	02-081
Price unit	1

### QR code



### Specification

Application	Connecting component for fixing two crossing area
	profile rails.

### Technical data

Material	Steel
Surface	galvanized
Corrosion category	C2 very high
Surrounding area	Indoor area

### Product details

Load $F_z$	3,5 kN
Height h	52 mm
Length	130 mm
Length inside	45 mm
Width material	35 mm
Material thickness	4 mm
Elongated hole	13x17,5 mm
Profile type	45/52
Hole distance	98 mm
Terminal hole	13 mm