

■ Head profile C-profile 45/26 Height 26 mm Elongated hole 17,5x13 mm

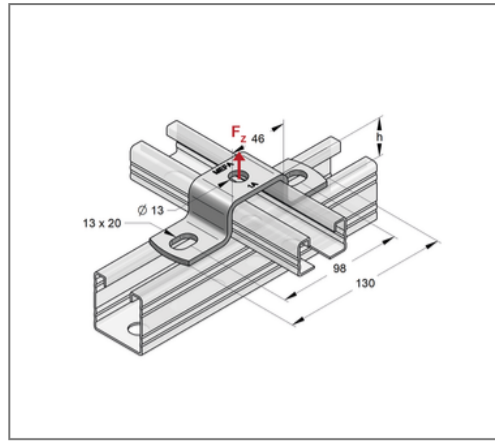
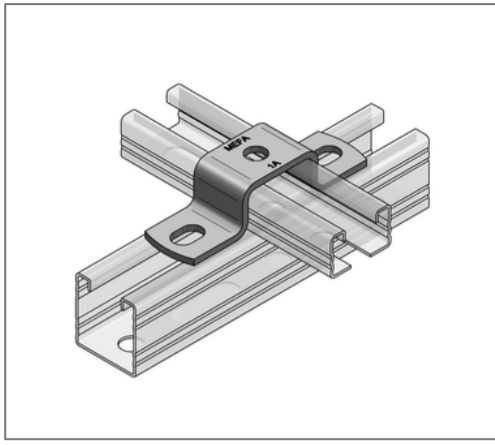

Commercial details

Part no.	08162326
EAN/GTIN	4250928420213
Packing unit	25 pcs
Quantity unit	pcs
Weight	0,176 kg/pc
Product group	02-081
Price unit	1

QR code



Specification

Application	Connecting component for fixing two crossing area
	profile rails.

Technical data

Material	Steel
Surface	galvanized
Corrosion category	C2 very high
Surrounding area	Indoor area

Product details

Load F_z	3,5 kN
Height h	26 mm
Length	130 mm
Length inside	45 mm
Width material	35 mm
Material thickness	4 mm
Elongated hole	13x17,5 mm
Profile type	45/26
Hole distance	98 mm
Terminal hole	13 mm