

■ Angle connector C-profile 45 90° Number of wings 2

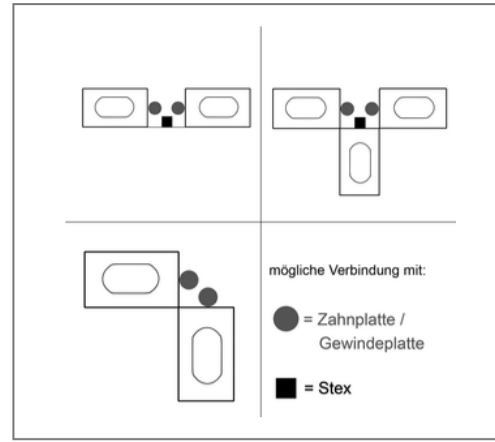
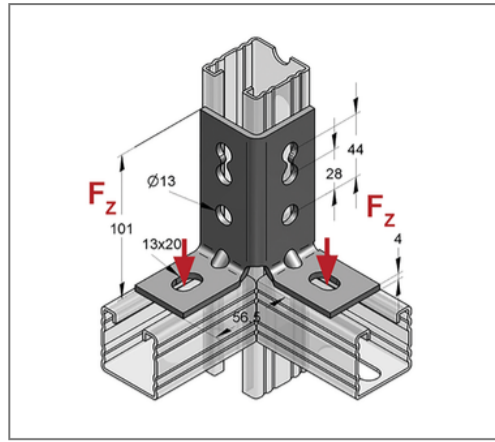
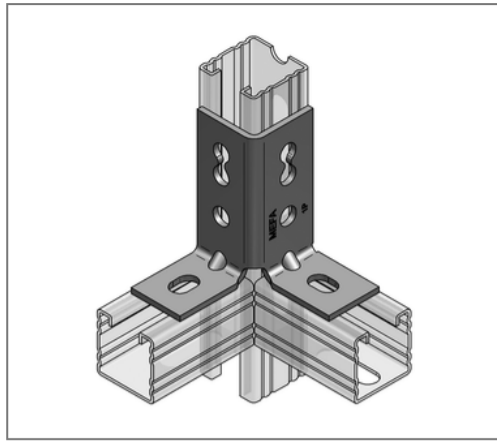

Commercial details

Part no.	08123200
EAN/GTIN	4250928419682
Packing unit	15 pcs
Quantity unit	pcs
Weight	0,367 kg/pc
Product group	02-081
Price unit	1

QR code



Specification

Application area	For connecting profile rails.
Profile	C-profile
Profile type	45
Number of wings	2

Technical data

Material	Steel
Material type	S235
Surface	galvanized
Corrosion category	C2 very high
Surrounding area	val.Innenbereich

Product details

Load F_z without profile	2,5 kN
Load F_z with profile	4 kN
Material thickness	4 mm
mounting angle	90 °
Elongated hole	20 mmx13
Length wing	56,5 mm
Width wing	45 mm
Hole-Ø	13 mm