

■ Pipe clamp Maxima PSM 30x3 120 - 124 mm M16 unlined

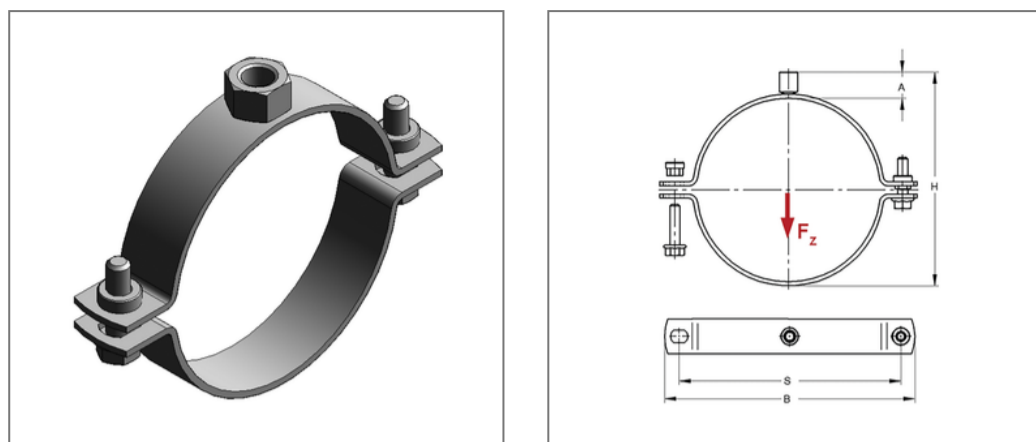

Commercial details

Part no.	008164301
EAN/GTIN	4250928455130
Packing unit	1 pcs
Quantity unit	pcs
Weight	0,445 kg/pc
Product group	01-008
Price unit	100

QR code



Certification



Specification

Application area	Pipe clamp for fastening pipes.
Specification	two-part
Connection	M16
Closure	Pendulum stick nuts

Product details

Center distance S	158 mm
Connection height A	23 mm
Width B	184 mm
Height H	146 - 150 mm
Material dimension	30x3 mm
Load F_z	4 kN
Clamping range	120 - 124 mm
Closure screw	M8

Technical data

Material	Steel
Material type	S235
Surface	galvanized
Corrosion category	C2 very high
Surrounding area	Indoor area
Sound insulation lining	unlined

Remark

Delivery time	5 working days ex works
Notice	With thread M16 or sleeve 1/2 Inch exchange and return are excluded. Suitable connection adaptors see chapter 1.