

■ Pipe clamp Maxima PSM 30x3 84 - 90 mm M10/M12 TPE

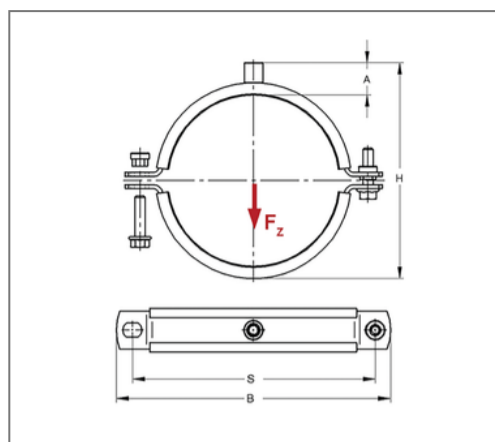

Commercial details

Part no.	008010701
EAN/GTIN	4250928454836
Packing unit	1 pcs
Quantity unit	pcs
Weight	0,434 kg/pc
Product group	01-008
Price unit	100

QR code



Certification



Specification

Application area	Pipe clamp for fastening pipes.
Specification	two-part
Connection	M10/M12
Closure	Pendulum stick nuts

Technical data

Material	Steel
Material type	S235
Surface	galvanized
Corrosion category	C2 very high
Surrounding area	Indoor area
Insulation thickness	6 mm
Temperature resistance	-35 °C - 100 °C
Sound insulation lining	TPE

Product details

Center distance S	136 mm
Connection height A	30 mm
Width B	162 mm
Colour sound insulation lining	black
Height H	123 - 129 mm
Material dimension	30x3 mm
Load F_z	1,7 kN
Clamping range	84 - 90 mm
Outside pipe diameter inch	val.RohraußendurchmesserZoll. 3 inch
Closure screw	M8

Remark

Delivery time	5 working days ex works
Notice	With thread M16 or sleeve 1/2 Inch exchange and return are excluded. Suitable connection adaptors see chapter 1.