

■ Stex 45 Threaded bolt GB M12 x 90 mm

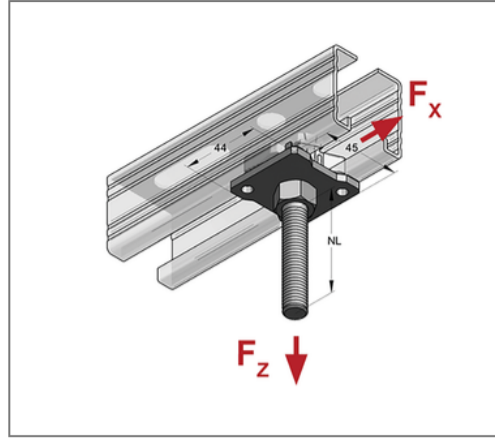
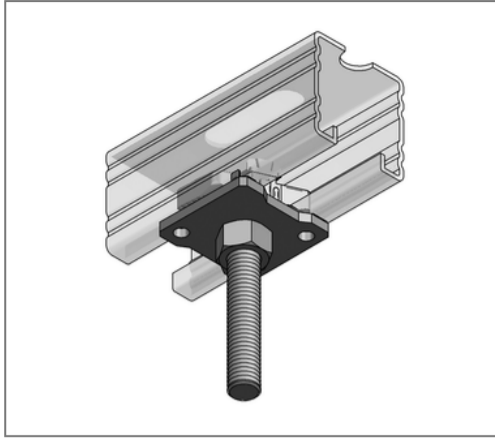

Commercial details

Part no.	1283090
EAN/GTIN	4250928424853
Packing unit	20 pcs
Quantity unit	pcs
Weight	0,189 kg/pc
Product group	02-128
Price unit	1

QR code



Specification

Application Quick-fixing system for direct pipe clamp area attachment to Stex profile rails with permanently integrated threaded bolt and nut.

Technical data

Material	Steel
Material type	S235
Surface	galvanized
Corrosion category	C2 very high
Surrounding area	Indoor area
Strength class	4.6

Product details

Thread	M12
Length thread	90 mm
Usable length	47 mm