

■ Stex 45 Threaded bolt GB M8 x 130 mm

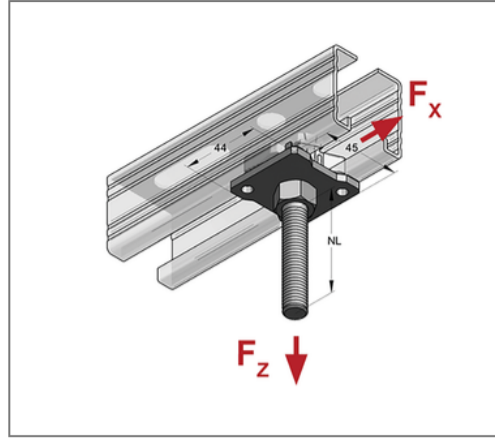
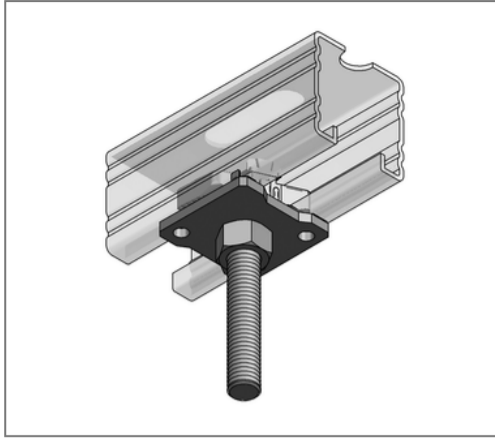

Commercial details

Part no.	1281130
EAN/GTIN	4250928424778
Packing unit	20 pcs
Quantity unit	pcs
Weight	0,160 kg/pc
Product group	02-128
Price unit	1

QR code



Specification

Application Quick-fixing system for direct pipe clamp area attachment to Stex profile rails with permanently integrated threaded bolt and nut.

Technical data

Material	Steel
Material type	S235
Surface	galvanized
Corrosion category	C2 very high
Surrounding area	Indoor area
Strength class	4.6

Product details

Thread	M8
Length thread	130 mm
Usable length	91 mm