

■ Flat connector L-shape for C-profile 35, Stex 35 Hole 10,5 mm

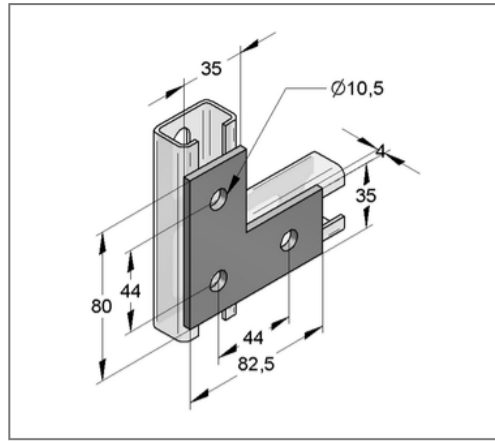
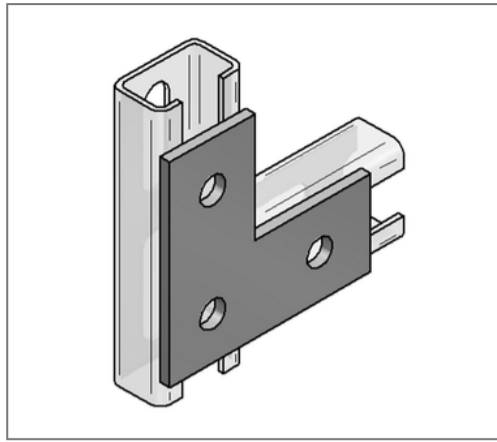

Commercial details

Part no.	0814430
EAN/GTIN	4250928419989
Packing unit	25 pcs
Quantity unit	pcs
Weight	0,135 kg/pc
Product group	02-081
Price unit	1

QR code

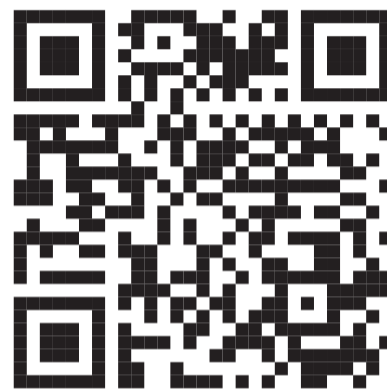

Specification

Application area	For butt joints of profiles.
Profile type	35, Stex 35

Technical data

Material	Steel
Material type	S235
Surface	galvanized
Corrosion category	C2 very high
Surrounding area	Indoor area

Product details

Width	80 mm
Length	82,5 mm
Hole-Ø	10,5 mm
Thickness	4 mm