

■ Threaded plate M10 square 30x22 mm galv.

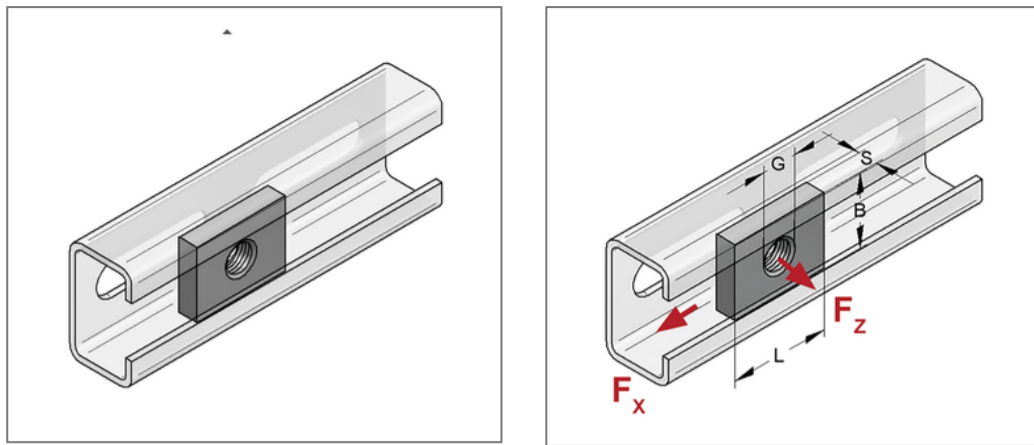

Commercial details

Part no.	0750810
EAN/GTIN	4250928417275
Packing unit	100 pcs
Quantity unit	pcs
Weight	0,0283 kg/pc
Product group	02-075
Price unit	100

QR code



Technical data

Material	Steel
Material type	S235
Surface	galvanized
Corrosion category	C2 very high
Surrounding area	Indoor area

Product details

Loading capacity	see loads in the catalogue
Length L	30 mm
Width B	22 mm
Material thickness S	6 mm
Thread G	M10
Profile type	27, 35
Shape	square