

## ■ Hammer head C-profile 35 M12 x 35 mm

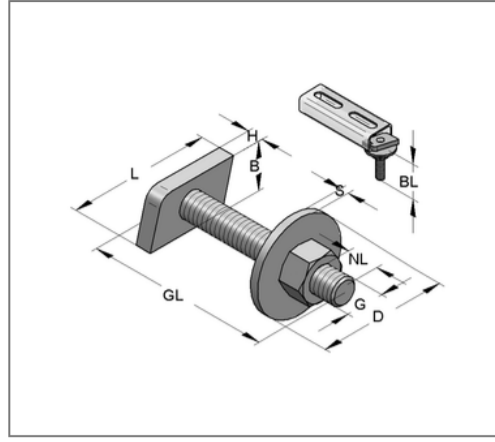
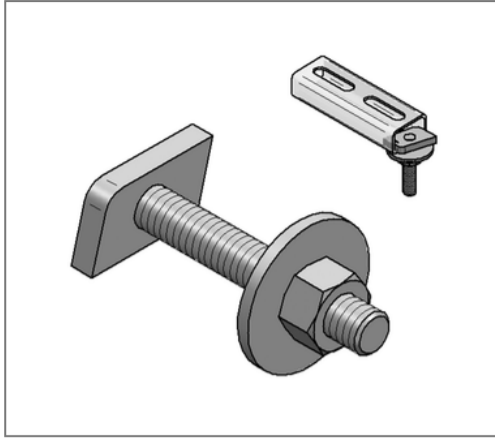

### Commercial details

Part no.	0698040
EAN/GTIN	4250928415844
Packing unit	50 pcs
Quantity unit	pcs
Weight	0,0853 kg/pc
Product group	02-069
Price unit	100

### QR code



### Specification

Application area	Direct attachment of pipe clamps to profile rails.
Profile type	35, Stex 35
Type of attachment	glide fast connection

### Technical data

Material	Steel
Material type	S235
Surface	galvanized
Corrosion category	C2 very high
Surrounding area	Indoor area

### Product details

Thread G	M12
Length thread GL	35 mm
Usable length NL	14 mm
Overall length BL	27 mm
Length hammer head L	35 mm
Width hammer head B	18 mm
Thickness hammer head H	6 mm
Diameter washer D	37 mm
Thickness washer S	3 mm