

■ Stex 35 Threaded bolt GB M10 x 130 mm

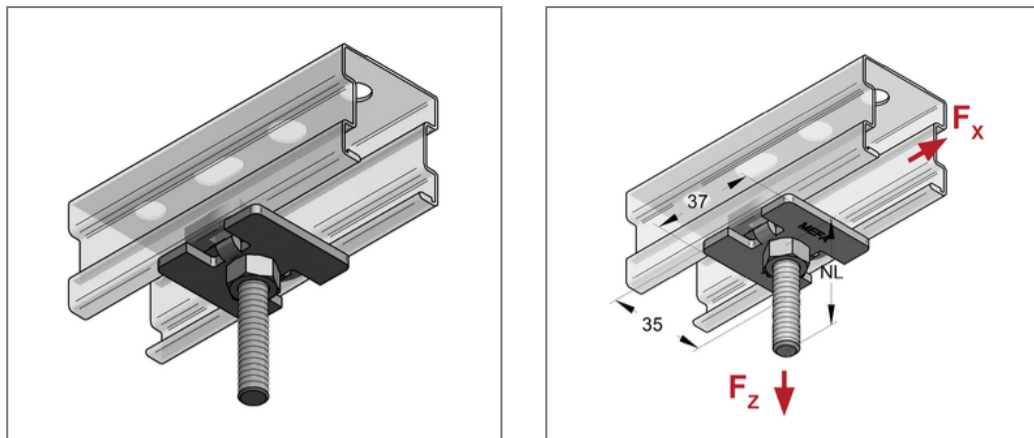

Commercial details

Part no.	127013001
EAN/GTIN	4250928424303
Packing unit	25 pcs
Quantity unit	pcs
Weight	0,117 kg/pc
Product group	02-127
Price unit	1

QR code



Specification

Application Quick-fixing system for direct pipe clamp area attachment to Stex profile rails with permanently integrated threaded bolt and nut.

Technical data

Material	Steel
Material type	S235
Surface	galvanized
Corrosion category	C2 very high
Surrounding area	Indoor area

Product details

Thread	M10
Length thread	130 mm
Usable length	114 mm