

■ Stex 35 Threaded bolt GB M8 x 50 mm

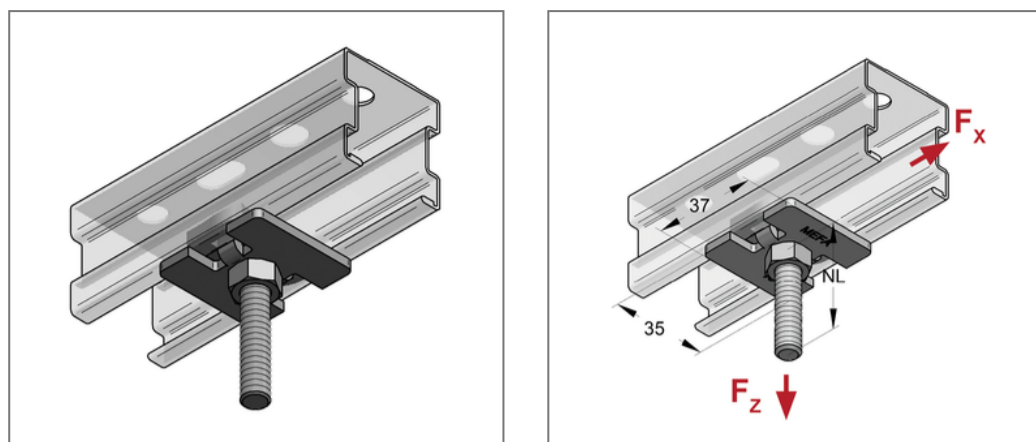

Commercial details

Part no.	127805001
EAN/GTIN	4250928424600
Packing unit	50 pcs
Quantity unit	pcs
Weight	0,0601 kg/pc
Product group	02-127
Price unit	1

QR code



Specification

Application Quick-fixing system for direct pipe clamp area attachment to Stex profile rails with permanently integrated threaded bolt and nut.

Technical data

Material	Steel
Material type	S235
Surface	galvanized
Corrosion category	C2 very high
Surrounding area	Indoor area

Product details

Thread	M8
Length thread	50 mm
Usable length	36 mm