

## ■ Visible pipe clamp 20x1 22 mm TPE

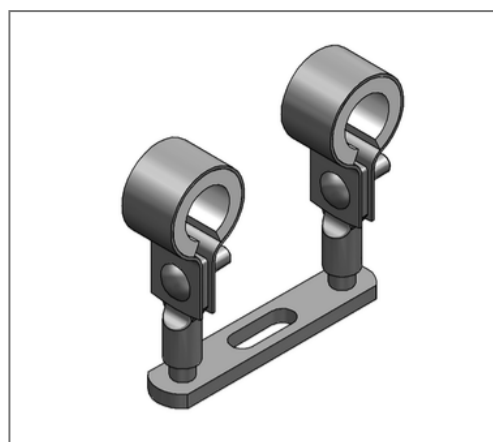
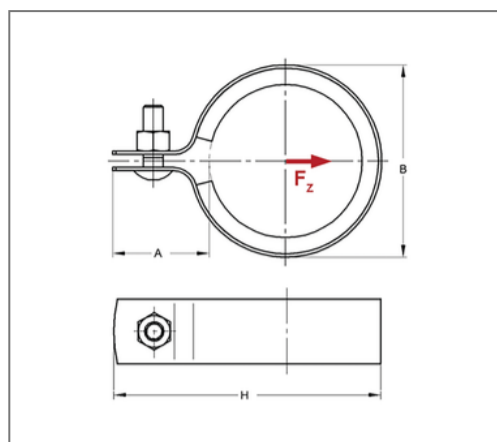
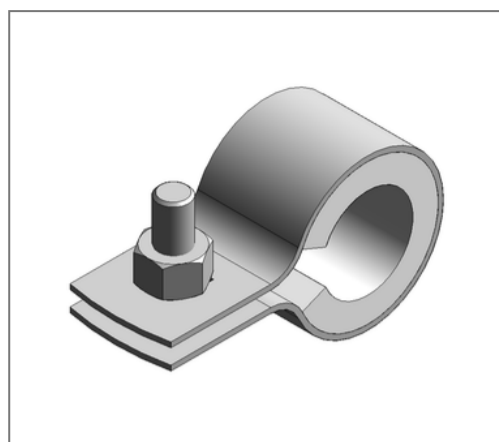

### Commercial details

Part no.	0311220
EAN/GTIN	4250928407658
Packing unit	100 pcs
Quantity unit	pcs
Weight	0,0405 kg/pc
Product group	01-033
Price unit	100

### QR code



### Certification



### Specification

Application area	Pipe clamp for fastening pipes.
Specification	one-part
Closure	Screw coupling

### Technical data

Material	Steel
Material type	DC01-A, DD11
Surface	galvanized
Corrosion category	C2 very high
Surrounding area	Indoor area
Insulation thickness	5 mm
Temperature resistance	-35 °C - 100 °C
Sound insulation lining	TPE

### Product details

Connection height A	31 mm
Width B	38 mm
Colour sound insulation lining	white
Height H	61 mm
Material dimension	20x1 mm
Load $F_z$	0,65 kN
Outer pipe diameter	22 mm
Outside pipe diameter inch	val.RohraußendurchmesserZoll. 1/2 inch
Closure screw	M6

### Remark

Notice	suitable double holders see chapter 5
--------	---------------------------------------