

## ■ Pipe clamp Titan HD 50x5 219 mm M16 unlined

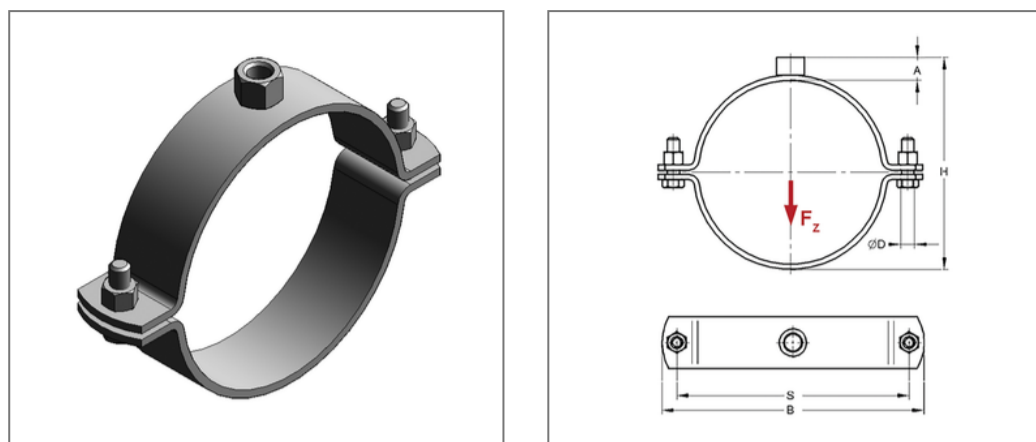

### Commercial details

Part no.	0071804
EAN/GTIN	4250928403605
Packing unit	1 pcs
Quantity unit	pcs
Weight	1,77 kg/pc
Product group	01-007
Price unit	100

### QR code



### Certification



### Specification

Application	Pipe clamp for fastening pipes in the heavy area
Specification	two-part
Connection	M16
Closure	Screw coupling

### Product details

Center distance S	270 mm
Connection height A	20 mm
Width B	299 mm
Height H	244 mm
Material dimension	50x5 mm
Load $F_z$	16 kN
Outer pipe diameter	219 mm
Outside pipe diameter inch	val.RohraußendurchmesserZoll.8 inch
Closure screw	M12

### Technical data

Material	Steel
Material type	S235
Surface	galvanized
Corrosion category	C2 very high
Surrounding area	Indoor area
Sound insulation lining	unlined

### Remark

Delivery time	5 - 8 working days ex works. Exchange and return are excluded.
---------------	--