

■ Pipe clamp Titan HD 50x5 168 mm M16 unlined

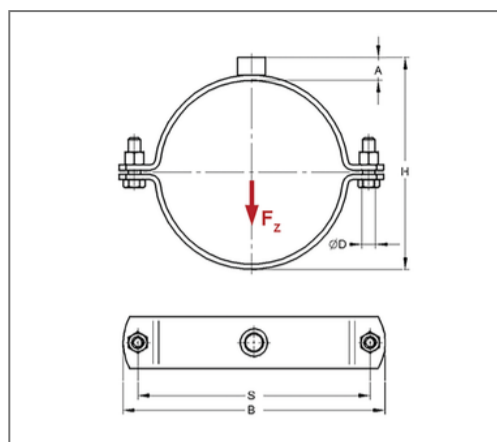

Commercial details

Part no.	0071687
EAN/GTIN	4250928403490
Packing unit	1 pcs
Quantity unit	pcs
Weight	1,44 kg/pc
Product group	01-007
Price unit	100

QR code



Certification



Specification

Application	Pipe clamp for fastening pipes in the heavy area
Specification	two-part
Connection	M16
Closure	Screw coupling

Product details

Center distance S	218 mm
Connection height A	20 mm
Width B	247 mm
Height H	193 mm
Material dimension	50x5 mm
Load F_z	6 kN
Outer pipe diameter	168 mm
Closure screw	M12

Technical data

Material	Steel
Material type	S235
Surface	galvanized
Corrosion category	C2 very high
Surrounding area	Indoor area
Sound insulation lining	unlined

Remark

Delivery time	5 - 8 working days ex works. Exchange and return are excluded.
---------------	--