

## ■ Pipe clamp Titan HD 50x5 160 mm M16 Silicone

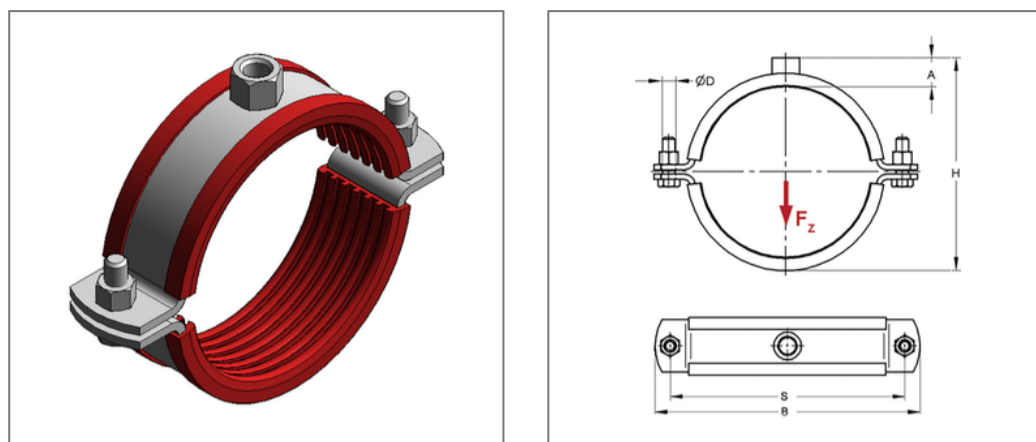

### Commercial details

Part no.	0076686
EAN/GTIN	4250928405029
Packing unit	1 pcs
Quantity unit	pcs
Weight	1,66 kg/pc
Product group	01-007
Price unit	100

### QR code



### Certification



### Specification

Application	pipe clamp, sound-insulated for fastening pipes area in the heavy load range.
Specification	two-part
Connection	M16
Closure	Screw coupling

### Product details

Center distance S	222 mm
Connection height A	26 mm
Width B	251 mm
Colour sound insulation lining	red
Height H	197 mm
Material dimension	50x5 mm
load $F_z$	3,2 kN
Outer pipe diameter	160 mm
Closure screw	M12

### Technical data

Material	Steel
Material type	S235
Surface	galvanized
Insulation thickness	6 mm
Temperature resistance	-50 °C - 250 °C
Sound insulation lining	Silicone

### Remark

Delivery time	5 - 8 working days ex works. Exchange and return are excluded.
---------------	--