

■ Pipe clamp Titan HD 50x5 133 mm M16 Silicone

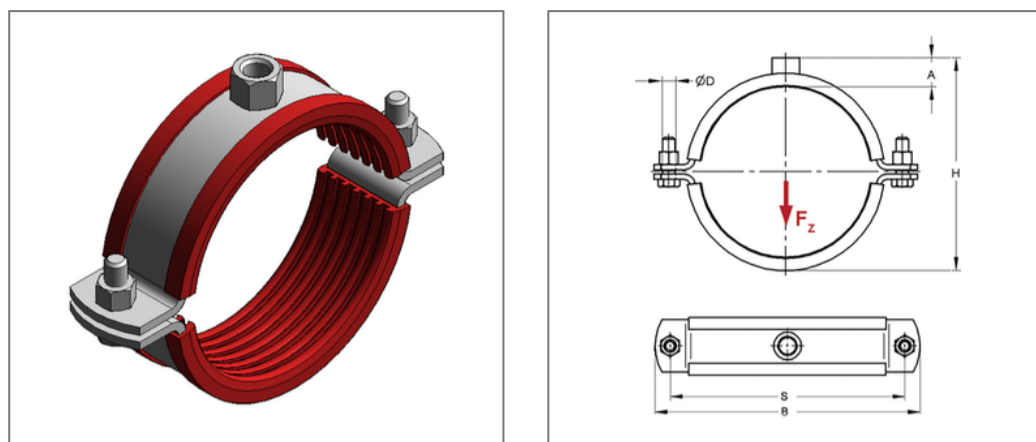

Commercial details

Part no.	0076600
EAN/GTIN	4250928404985
Packing unit	1 pcs
Quantity unit	pcs
Weight	1,45 kg/pc
Product group	01-007
Price unit	100

QR code



Certification



Specification

Application	pipe clamp, sound-insulated for fastening pipes area
Specification	two-part
Connection	M16
Closure	Screw coupling

Product details

Center distance S	195 mm
Connection height A	26 mm
Width B	224 mm
Colour sound insulation lining	red
Height H	170 mm
Material dimension	50x5 mm
load F_z	3,2 kN
Outer pipe diameter	133 mm
Closure screw	M12

Technical data

Material	Steel
Material type	S235
Surface	galvanized
Insulation thickness	6 mm
Temperature resistance	-50 °C - 250 °C
Sound insulation lining	Silicone

Remark

Delivery time	5 - 8 working days ex works. Exchange and return are excluded.
---------------	--