

■ Pipe clamp Titan HD 50x5 200 mm M12 Silicone

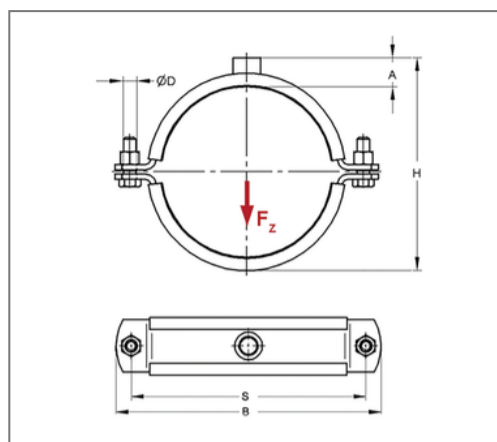
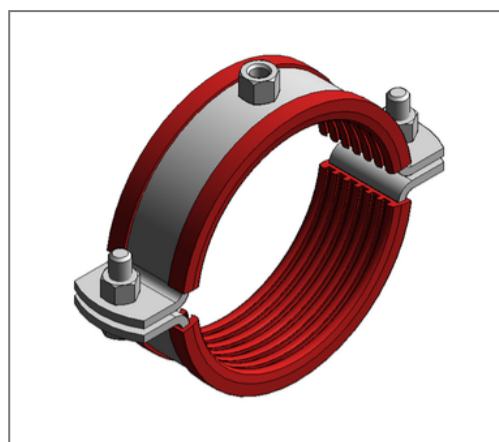

Commercial details

Part no.	0067784
EAN/GTIN	4250928402233
Packing unit	1 pcs
Quantity unit	pcs
Weight	1,94 kg/pc
Product group	01-007
Price unit	100

QR code



Certification



Specification

Application	pipe clamp, sound-insulated for fastening pipes area in the heavy load range.
Specification	two-part
Connection	M12
Closure	Screw coupling

Product details

Center distance S	263 mm
Connection height A	22 mm
Width B	292 mm
Colour sound insulation lining	red
Height H	233 mm
Material dimension	50x5 mm
load F_z	11,5 kN
Outer pipe diameter	200 mm
Closure screw	M12

Technical data

Material	Steel
Material type	S235
Surface	galvanized
Insulation thickness	6 mm
Temperature resistance	-50 °C - 250 °C
Sound insulation lining	Silicone

Remark

Delivery time	5 - 8 working days ex works. Exchange and return are excluded.
---------------	--