

■ Pipe clamp Titan HD 50x5 165 mm 1" TPE

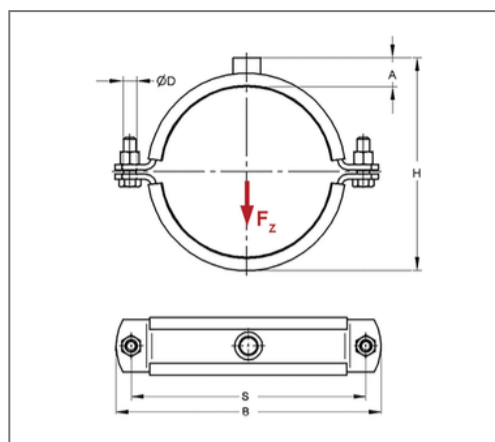

Commercial details

Part no.	0074691
EAN/GTIN	4250928404589
Packing unit	1 pcs
Quantity unit	pcs
Weight	1,74 kg/pc
Product group	01-007
Price unit	100

QR code



Certification



Specification

Application	Pipe clamp, sound-insulated for fastening pipes in the heavy load range.
Specification	two-part
Connection	1"
Closure	Screw coupling

Technical data

Material	Steel
Material type	S235
Surface	galvanized
Corrosion category	C2 very high
Surrounding area	Indoor area
Insulation thickness	6 mm
Temperature resistance	-35 °C - 100 °C
Sound insulation lining	TPE

Product details

Center distance S	227 mm
Connection height A	31 mm
Width B	256 mm
Colour sound insulation lining	black
Height H	207 mm
Material dimension	50x5 mm
Load F_z	3,2 kN
Outer pipe diameter	165 mm
Outside pipe diameter inch	val.RohraußendurchmesserZoll. 6 inch
Closure screw	M12

Remark

Delivery time	5 - 8 working days ex works. Exchange and return are excluded.
---------------	--