

■ Pipe clamp Titan HD 50x5 194 mm 1/2" TPE

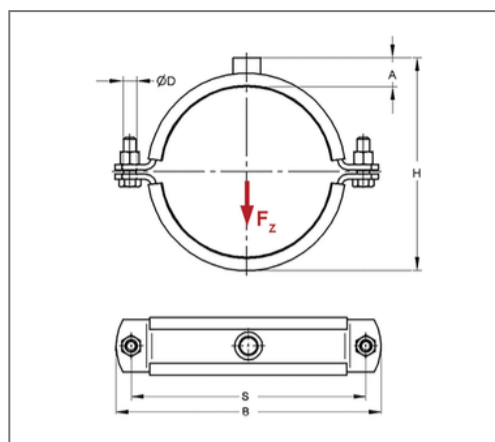

Commercial details

Part no.	0072761
EAN/GTIN	4250928404121
Packing unit	1 pcs
Quantity unit	pcs
Weight	1,91 kg/pc
Product group	01-007
Price unit	100

QR code



Certification



Specification

Application	Pipe clamp, sound-insulated for fastening pipes in the heavy load range.
Specification	two-part
Connection	1/2"
Closure	Screw coupling

Technical data

Material	Steel
Material type	S235
Surface	galvanized
Corrosion category	C2 very high
Surrounding area	Indoor area
Insulation thickness	6 mm
Temperature resistance	-35 °C - 100 °C
Sound insulation lining	TPE

Product details

Center distance S	257 mm
Connection height A	26 mm
Width B	286 mm
Colour sound insulation lining	black
Height H	231 mm
Material dimension	50x5 mm
Load F_z	11,5 kN
Outer pipe diameter	194 mm
Closure screw	M12

Remark

Delivery time 5 - 8 working days ex works. Exchange and return are excluded.