

■ Pipe clamp Maxima PSM 35x4 210 - 215 mm M16 unlined

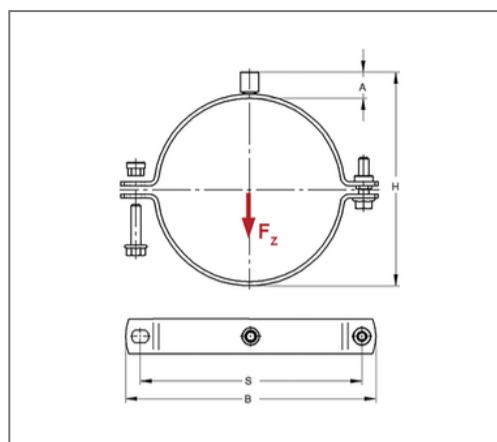
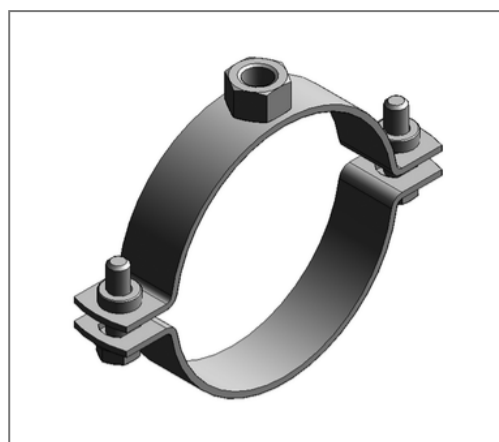

Commercial details

Part no.	0081762
EAN/GTIN	4250928406231
Packing unit	1 pcs
Quantity unit	pcs
Weight	1,00 kg/pc
Product group	01-008
Price unit	100

QR code



Certification



Specification

Application area	Pipe clamp for fastening pipes.
Specification	two-part
Connection	M16
Closure	Pendulum stick nuts

Product details

Center distance S	258 mm
Connection height A	24 mm
Width B	288 mm
Height H	238 - 243 mm
Material dimension	35x4 mm
Load F_z	6,3 kN
Clamping range	210 - 215 mm
Closure screw	M10

Technical data

Material	Steel
Material type	S235
Surface	galvanized
Corrosion category	C2 very high
Surrounding area	Indoor area
Sound insulation lining	unlined

Remark

Delivery time	5 working days ex works
Notice	With thread M16 or sleeve 1/2 Inch exchange and return are excluded. Suitable connection adaptors see chapter 1.