

■ Pipe clamp Maxima PSM 35x4 225 - 230 mm M16 Silicone

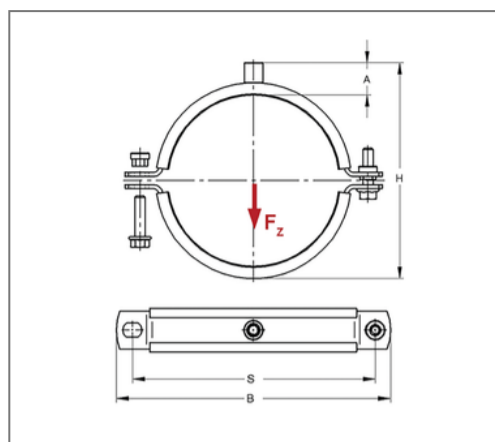
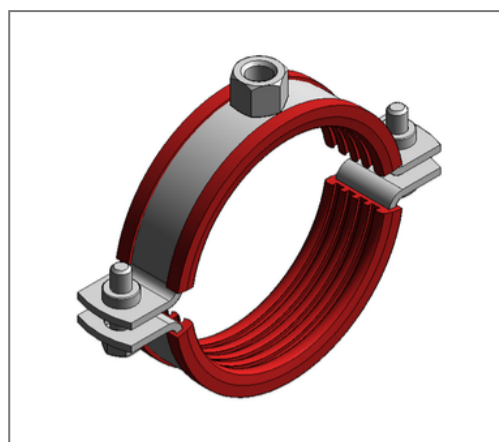

Commercial details

Part no.	0084816
EAN/GTIN	4250928407054
Packing unit	1 pcs
Quantity unit	pcs
Weight	1,29 kg/pc
Product group	01-008
Price unit	100

QR code



Certification



Specification

Application area	Pipe clamp for fastening pipes.
Specification	two-part
Connection	M16
Closure	Pendulum stick nuts

Technical data

Material	Steel
Material type	S235
Surface	galvanized
Corrosion category	C2 very high
Surrounding area	Indoor area
Insulation thickness	6 mm
Temperature resistance	-50 °C - 250 °C
Sound insulation lining	Silicone

Product details

Center distance S	284 mm
Connection height A	30 mm
Width B	314 mm
Colour sound insulation lining	red
Height H	265 - 270 mm
Material dimension	35x4 mm
Load F_z	5 kN
Clamping range	225 - 230 mm
Closure screw	M10

Remark

Delivery time	5 working days ex works
Notice	With thread M16 or sleeve 1/2 Inch exchange and return are excluded. Suitable connection adaptors see chapter 1.