

■ Pipe clamp Maxima PSM 35x4 164 - 168 mm M10/M12 TPE

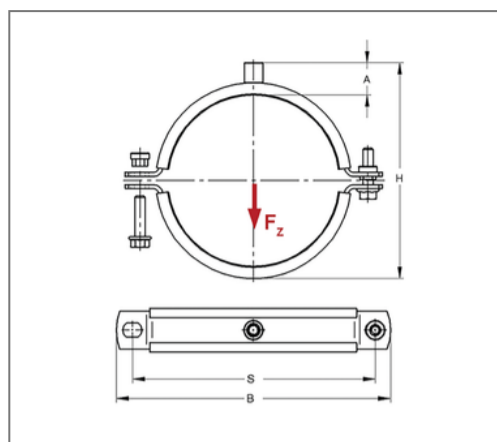

Commercial details

Part no.	0080222
EAN/GTIN	4250928405920
Packing unit	1 pcs
Quantity unit	pcs
Weight	1,01 kg/pc
Product group	01-008
Price unit	100

QR code



Certification



Specification

Application area	Pipe clamp for fastening pipes.
Specification	two-part
Connection	M10/M12
Closure	Pendulum stick nuts

Technical data

Material	Steel
Material type	S235
Surface	galvanized
Corrosion category	C2 very high
Surrounding area	Indoor area
Insulation thickness	6 mm
Temperature resistance	-35 °C - 100 °C
Sound insulation lining	TPE

Product details

Center distance S	222 mm
Connection height A	31 mm
Width B	252 mm
Colour sound insulation lining	black
Height H	205 - 209 mm
Material dimension	35x4 mm
Load F_z	5 kN
Clamping range	164 - 168 mm
Outside pipe diameter inch	val.RohraußendurchmesserZoll. 6 inch
Closure screw	M10

Remark

Delivery time	5 working days ex works
Notice	With thread M16 or sleeve 1/2 Inch exchange and return are excluded. Suitable connection adaptors see chapter 1.