

## ■ Pipe clamp Maxima PSM 35x4 133 - 136 mm M10/M12 TPE

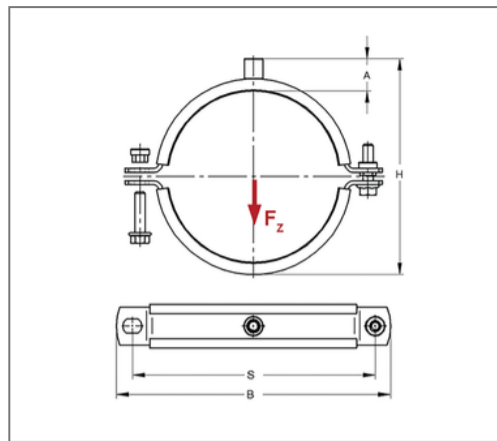

### Commercial details

Part no.	0088136
EAN/GTIN	4250928407337
Packing unit	1 pcs
Quantity unit	pcs
Weight	0,867 kg/pc
Product group	01-008
Price unit	100

### QR code



### Certification



### Specification

Application area	Pipe clamp for fastening pipes.
Specification	two-part
Connection	M10/M12
Closure	Pendulum stick nuts

### Technical data

Material	Steel
Material type	S235
Surface	galvanized
Corrosion category	C2 very high
Surrounding area	Indoor area
Insulation thickness	6 mm
Temperature resistance	-35 °C - 100 °C
Sound insulation lining	TPE

### Product details

Center distance S	190 mm
Connection height A	31 mm
Width B	220 mm
Colour sound insulation lining	black
Height H	174 - 177 mm
Material dimension	35x4 mm
Load $F_z$	5 kN
Clamping range	133 - 136 mm
Closure screw	M10

### Remark

Delivery time	5 working days ex works
Notice	With thread M16 or sleeve 1/2 Inch exchange and return are excluded. Suitable connection adaptors see chapter 1.