

■ Sliding pipe clamp Omnia MB 20x2 63 mm M8/M10 EPDM

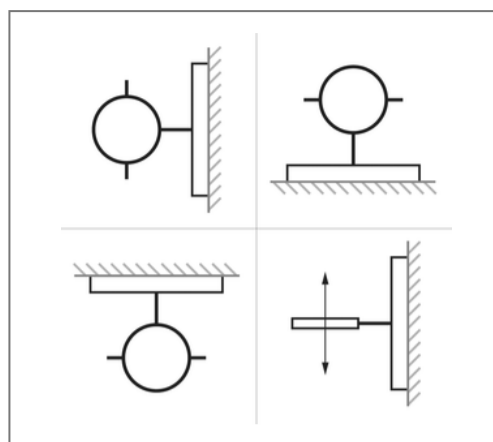
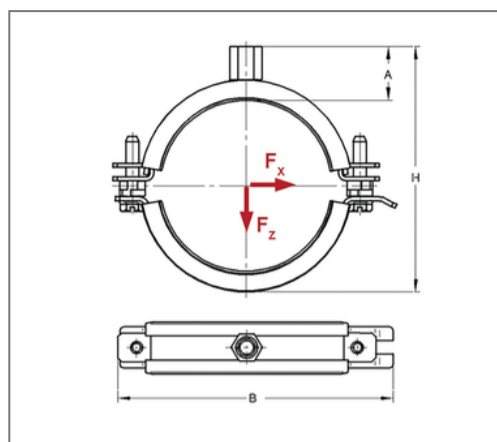
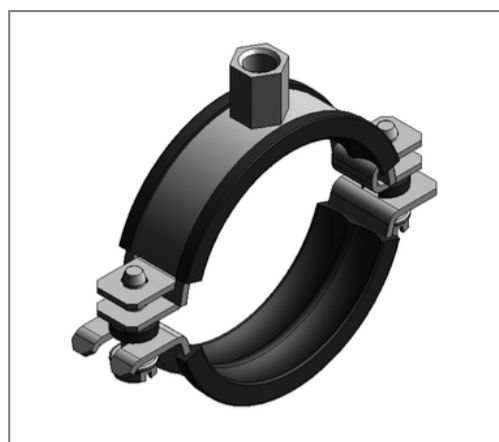

Commercial details

Part no.	0387263
EAN/GTIN	4250928408259
Packing unit	50 pcs
Quantity unit	pcs
Weight	0,140 kg/pc
Product group	01-140
Price unit	100

QR code



Certification



Specification

Application area	Pipe clamp for fastening pipes.
Specification	two-part
Connection	M8/M10
Closure	Sleivable U-closure

Technical data

Material	Steel
Material type	DD11
Surface	galvanized
Corrosion category	C2 very high
Surrounding area	Indoor area
Insulation thickness	3 mm
Temperature resistance	-30 °C - 70 °C
Sound insulation lining	Rubber EPDM flocked

Product details

Connection height A	24 mm
Width B	113 mm
Colour sound insulation lining	black
Height H	91 - 92 mm
Material dimension	20x2 mm
Load F_x	0,23 kN
Load F_z	0,5 kN
Outer pipe diameter	63 mm
Closure screw	M6

Remark

Notice	suitable connection adapter see chapter 1
--------	---