

## ■ Sliding pipe clamp Omnia MB 20x2 50 mm M8/M10 EPDM

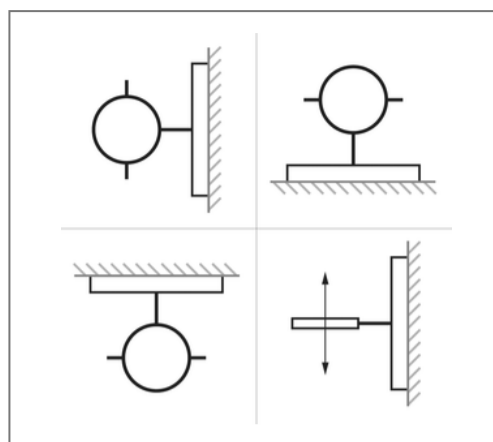
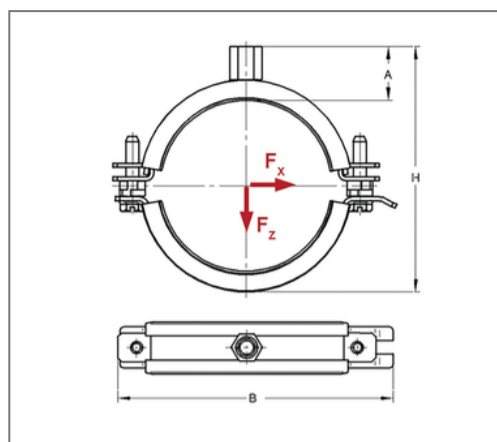
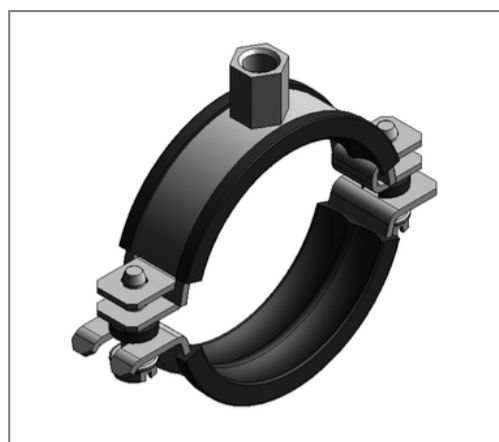

### Commercial details

Part no.	0387250
EAN/GTIN	4250928408211
Packing unit	50 pcs
Quantity unit	pcs
Weight	0,120 kg/pc
Product group	01-140
Price unit	100

### QR code



### Certification



### Specification

Application area	Pipe clamp for fastening pipes.
Specification	two-part
Connection	M8/M10
Closure	Sleuable U-closure

### Technical data

Material	Steel
Material type	DD11
Surface	galvanized
Corrosion category	C2 very high
Surrounding area	Indoor area
Insulation thickness	3 mm
Temperature resistance	-30 °C - 70 °C
Sound insulation lining	Rubber EPDM flocked

### Product details

Connection height A	24 mm
Width B	92 mm
Colour sound insulation lining	black
Height H	72 - 76 mm
Material dimension	20x2 mm
Load $F_x$	0,23 kN
Load $F_z$	0,5 kN
Outer pipe diameter	50 mm
Closure screw	M6

### Remark

Notice	suitable connection adapter see chapter 1
--------	---