

■ Pipe clamp Sigma 20x1 25 - 29 mm M8 EPDM

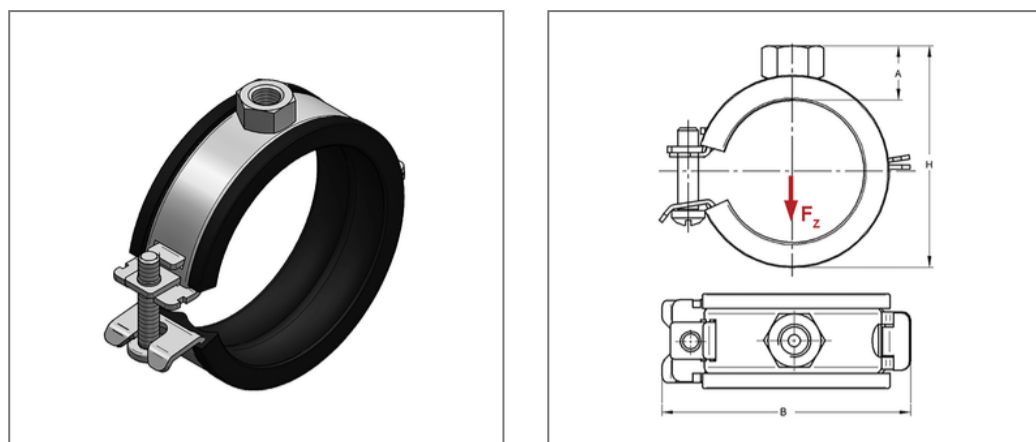

Commercial details

Part no.	14510291
EAN/GTIN	4250928432193
Packing unit	100 pcs
Quantity unit	pcs
Weight	0,0360 kg/pc
Product group	01-045
Price unit	100

QR code



Certification



Specification

Application area	Pipe clamp for fastening pipes.
Specification	one-part
Connection	M8
Closure	Sigma safety quick-closure

Technical data

Material	Steel
Material type	DC01-A, DD11
Surface	galvanized
Corrosion category	C2 very high
Surrounding area	Indoor area
Insulation thickness	3 mm
Temperature resistance	-35 °C - 100 °C
Sound insulation lining	Rubber EPDM

Product details

Connection height A	12 mm
Width B	56 mm
Colour sound insulation lining	black
Height H	43 - 47 mm
Material dimension	20x1 mm
Load F_z	0,45 kN
Clamping range	25 - 29 mm
Outside pipe diameter inch	val.RohraußendurchmesserZoll. 3/4 inch
Closure screw	M5