

■ Hexagon screw EN ISO 4017 M8 x 60 mm hot-dip galv. FK 8.8

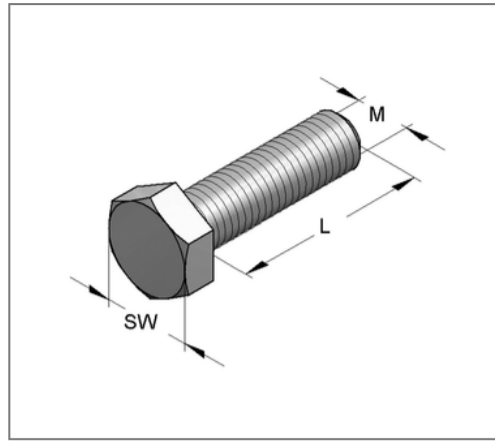
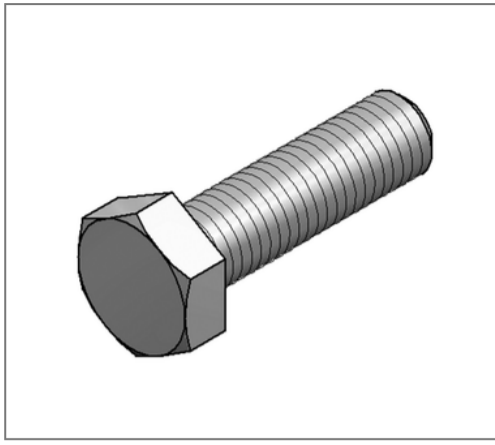

Commercial details

Part no.	3204601/fvz
EAN/GTIN	4250928470164
Packing unit	50 pcs
Quantity unit	pcs
Weight	0,0250 kg/pc
Product group	05-320
Price unit	100

QR code



Certification



Technical data

Material	Steel
Surface	hot-dip galvanized
Corrosion category	C4 high / C5 medium
Surrounding area	Indoor and outdoor areas
Norm	DIN EN ISO 4017
Strength class	8.8

Product details

Thread M	M8
Length L	60 mm
Wrench size SW	13
Shape head	Hexagon head