

■ OPTIMUM XLV adapter M10x20 mm

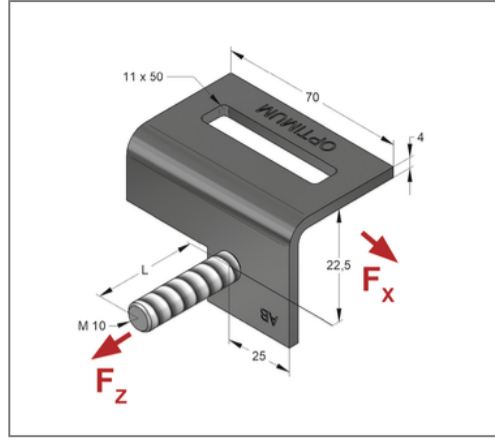

Commercial details

Part no.	08245008
EAN/GTIN	4250928470256
Packing unit	10 pcs
Quantity unit	pcs
Weight	0,159 kg/pc
Product group	02-085
Price unit	1

QR code



Certification



Specification

Application area	For adapting components such as base plates, Z-guides for sliding plates, ceiling hangers, sliding parts with lugs, roller bearings, etc.
Recommended accessories	OPTI-Lock M10x15

Installation advise The adapter must be used in pairs. The distance between them can be freely selected depending on the component part.

Technical data

Material	Steel
Surface	Zinc-Nickel
Corrosion category	C4 high / C5 medium
Surrounding area	Indoor and outdoor areas

Product details

Tightening torque bolt	10 Nm
Load F_x	6 kN
Load F_z	9 kN
Length	70 mm
Thickness	4 mm
Thread	M10
Length thread	20 mm