

■ Tooth plate S M12 36 x 20 mm galv.

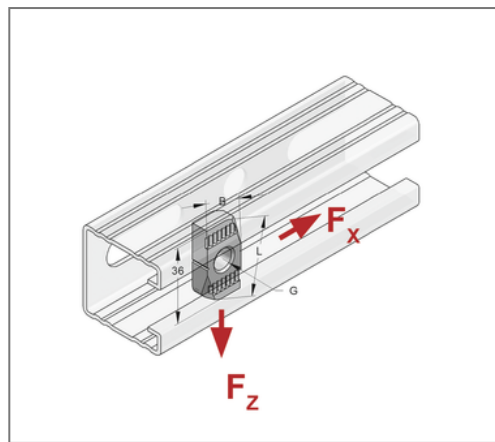
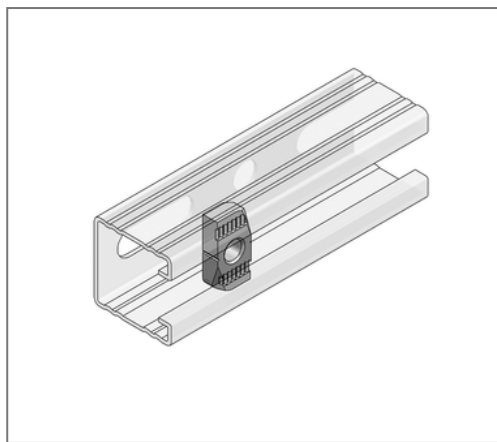

Commercial details

Part no.	081810302
EAN/GTIN	4250928466624
Packing unit	100 pcs
Quantity unit	pcs
Weight	0,0404 kg/pc
Product group	02-081
Price unit	1

QR code



Certification



Technical data

Material	Steel
Material type	S235
Surface	galvanized

Product details

Loading capacity	see loads in the catalogue
Length L	36 mm
Width B	20 mm
Material thickness	8 mm
Thread G	M12
Profile type	45
Shape	pivoted