

## ■ Threaded coupling hexagon Fem. thread M10 L= 40 mm

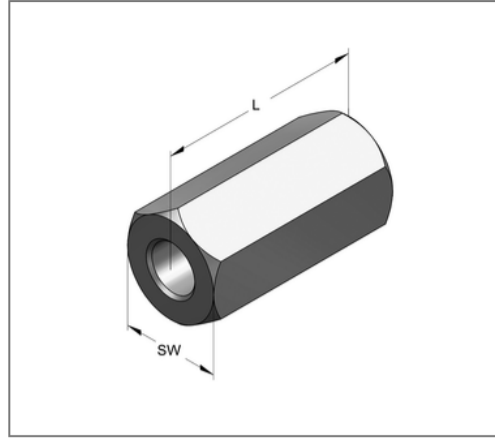
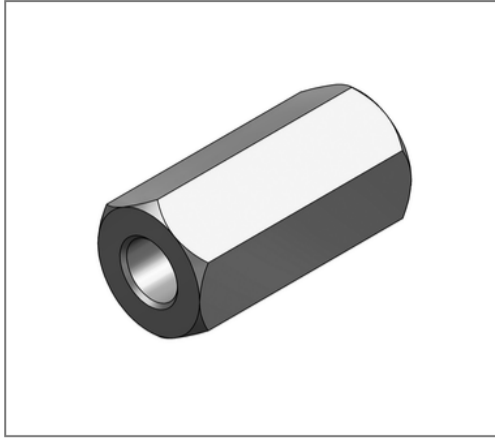

### Commercial details

Part no.	0700105
EAN/GTIN	4250928463821
Packing unit	50 pcs
Quantity unit	pcs
Weight	0,0285 kg/pc
Product group	05-070
Price unit	100

### QR code



### Technical data

Material	Steel
Surface	galvanized
Corrosion category	C2 very high
Surrounding area	Indoor area

### Product details

Length L	40 mm
Female thread 1 M	M10
Length female thread 1	40 mm
Wrench size SW	13