

## ■ Threaded coupling hexagon Fem. thread M8 L= 30 mm

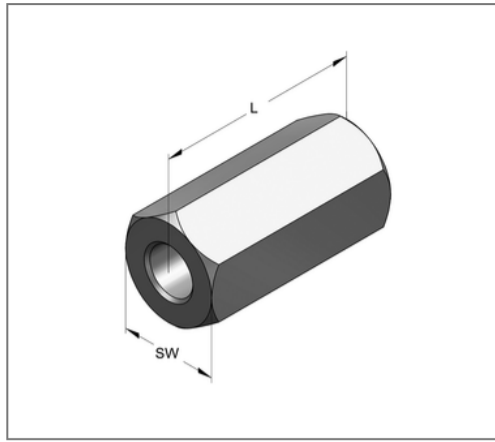
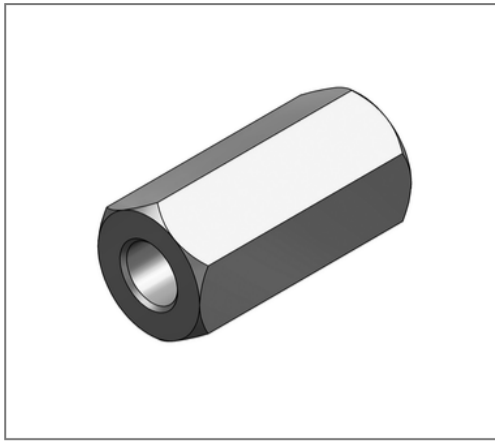

### Commercial details

Part no.	0700085
EAN/GTIN	4250928463814
Packing unit	100 pcs
Quantity unit	pcs
Weight	0,0135 kg/pc
Product group	05-070
Price unit	100

### QR code



### Technical data

Material	Steel
Surface	galvanized
Corrosion category	C2 very high
Surrounding area	Indoor area

### Product details

Length L	30 mm
Female thread 1 M	M8
Length female thread 1	30 mm
Wrench size SW	11