

## ■ Strap screw with washer 25 H8 x 50 mm SW 13 TX 30

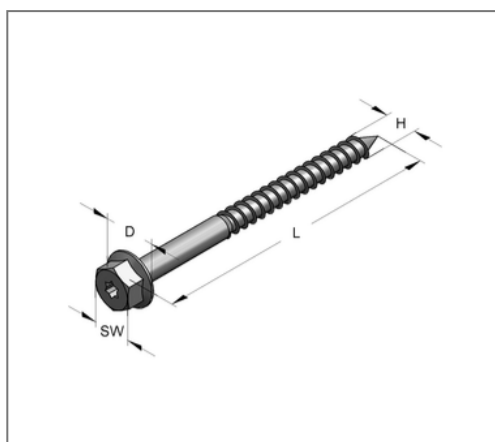

### Commercial details

Part no.	350001218
EAN/GTIN	4250928448491
Packing unit	100 pcs
Quantity unit	pcs
Weight	0,0197 kg/pc
Product group	05-350
Price unit	100

### QR code



### Specification

Specification with contact pressed washer

### Technical data

Material	Steel
Surface	galvanized
Corrosion category	C2 very high
Surrounding area	Indoor area

### Product details

Thread H	H8
Length L	50 mm
Wrench size SW	13
Diameter washer D	18 mm
Type dowel	10x44
Thickness washer	2 mm
TX drive	TX 30