

■ Pipe clamp Ventus 25x1,5 DN 300 M8 EPDM

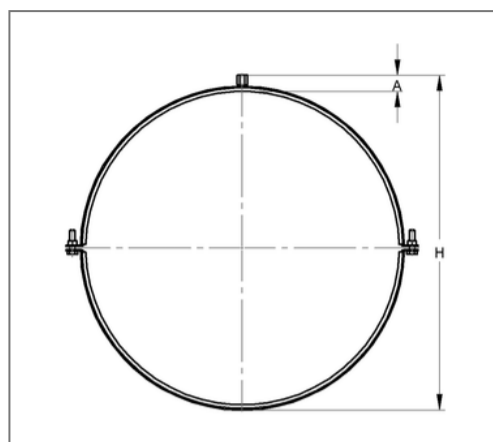
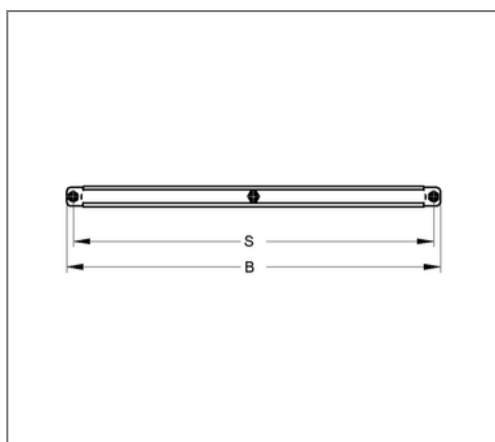

Commercial details

Part no.	0449931300
EAN/GTIN	4250928411310
Packing unit	10 pcs
Quantity unit	pcs
Weight	0,452 kg/pc
Product group	08-992
Price unit	100

QR code



Certification



Specification

Application area	Pipe clamp for fastening ventilation pipes.
Specification	two-part
Connection	M8
Closure	Closure screw

Technical data

Material	Steel
Material type	S235
Surface	galvanized
Corrosion category	C2 very high
Surrounding area	Indoor area
Insulation thickness	3 mm
Temperature resistance	-35 °C - 100 °C
Sound insulation lining	Rubber EPDM

Product details

Center distance S	340 mm
Connection height A	16 mm
Width B	358 mm
Colour sound insulation lining	black
Height H	325 mm
Material dimension	25x1,5 mm
Load F _z	1 kN
Outer pipe diameter	302 mm
Closure screw	M8