

## ■ Pipe clamp Ventus 20x1,5 DN 180 M8 EPDM

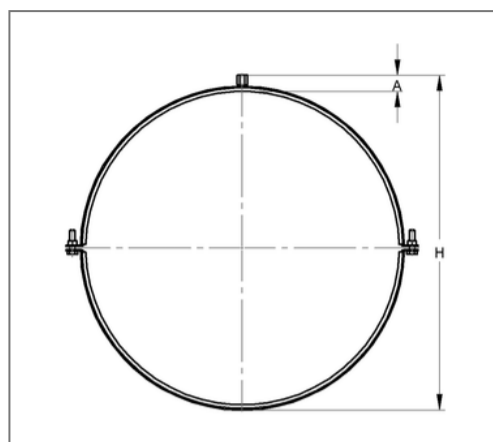
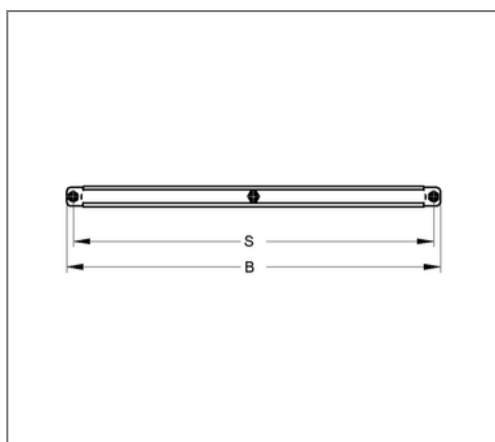

### Commercial details

Part no.	0449931180
EAN/GTIN	4250928411266
Packing unit	25 pcs
Quantity unit	pcs
Weight	0,220 kg/pc
Product group	08-992
Price unit	100

### QR code



### Certification



### Specification

Application area	Pipe clamp for fastening ventilation pipes.
Specification	two-part
Connection	M8
Closure	Snap-in closure

### Technical data

Material	Steel
Material type	S235
Surface	galvanized
Corrosion category	C2 very high
Surrounding area	Indoor area
Insulation thickness	3 mm
Temperature resistance	-35 °C - 100 °C
Sound insulation lining	Rubber EPDM

### Product details

Center distance S	210 mm
Connection height A	15 mm
Width B	228 mm
Colour sound insulation lining	black
Height H	202 mm
Material dimension	20x1,5 mm
Load $F_z$	0,75 kN
Outer pipe diameter	181 mm
Closure screw	M6