

■ Sliding sledge C 70 x 10 mm 813 mm EPDM hot-dip galv.

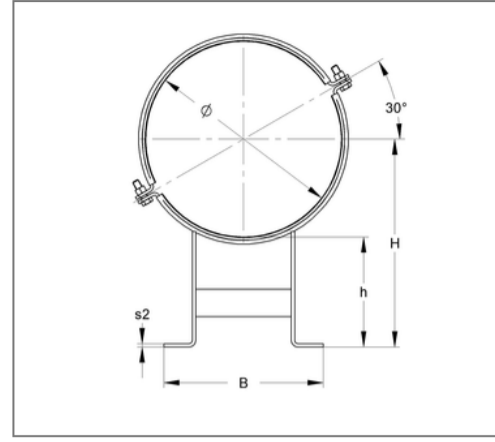
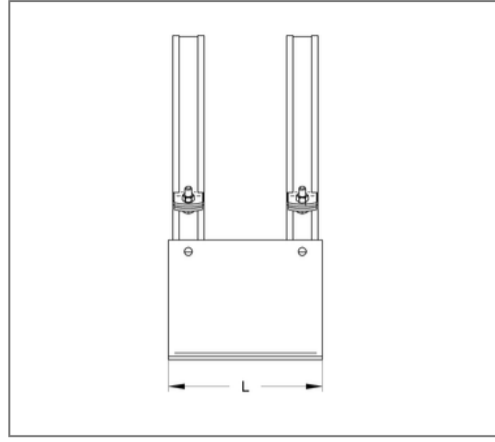

Commercial details

Part no.	110cfb0813
EAN/GTIN	4250928462527
Packing unit	1 pcs
Quantity unit	pcs
Weight	68,10 kg/pc
Product group	14-108
Price unit	1

QR code

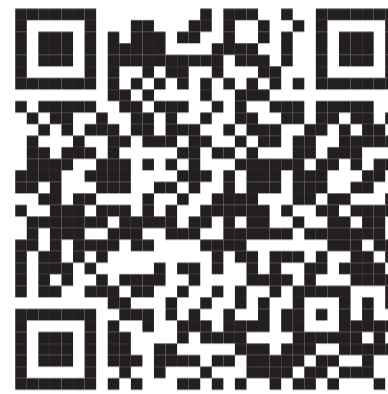

Specification

Specification	Double-L-support
Closure	Screw + nut

Technical data

Material	Steel
Material type	S235
Surface	hot-dip galvanized
Corrosion category	C4 high / C5 medium
Surrounding area	Indoor and outdoor areas
Insulation thickness	6 mm
min. temperature resistance	-35 °C
max. temperature resistance	100 °C
Sound insulation lining	Rubber EPDM
Safety factor	1,54

Product details

Closure screw	M20
Outer pipe diameter	813 mm
Axis height	607 mm
Material thickness	12 mm
Width pipe clamp strap	70 mm
Width substructure	509 mm
Length of substructure	470 mm
Load F_x	24,58 kN
Load F_y	5 kN

Product details

Load F_z standing μ 0,2	25 kN
Load F_z standing μ 0,3	16,67 kN
Load F_z hanging μ 0,2	25 kN
Load F_z hanging μ 0,3	16,67 kN
Thickness clamp strap	10 mm