

■ Sliding sledge C 50 x 5 mm 457 mm EPDM hot-dip galv.

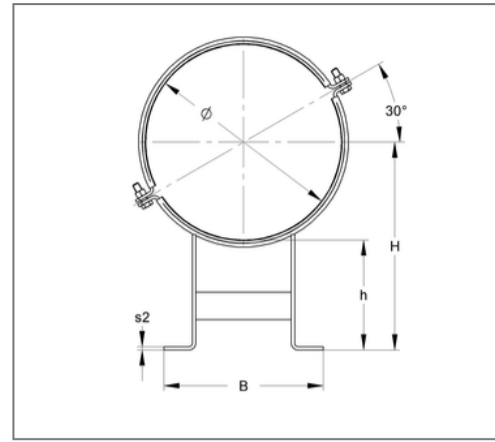
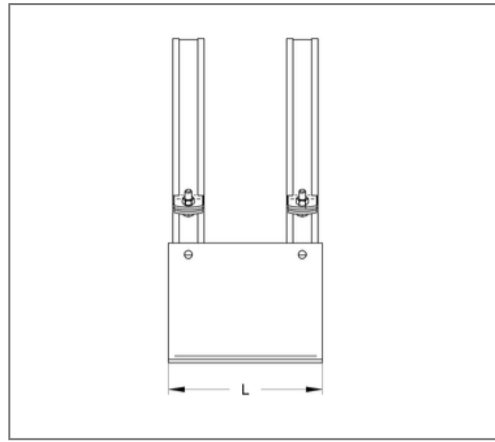
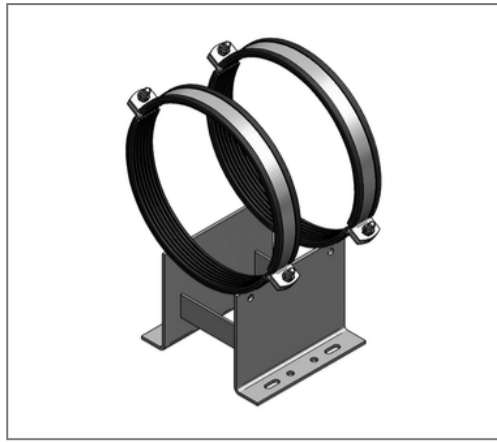

Commercial details

Part no.	110cfb0457
EAN/GTIN	4250928462473
Packing unit	1 pcs
Quantity unit	pcs
Weight	19,79 kg/pc
Product group	14-108
Price unit	1

QR code



Specification

Specification	Double-L-support
Closure	Screw + nut

Technical data

Material	Steel
Material type	S235
Surface	hot-dip galvanized
Corrosion category	C4 high / C5 medium
Surrounding area	Indoor and outdoor areas
Insulation thickness	6 mm
min. temperature resistance	-35 °C
max. temperature resistance	100 °C
Sound insulation lining	Rubber EPDM
Safety factor	1,54

Product details

Closure screw	M12
Outer pipe diameter	457 mm
Axis height	429 mm
Material thickness	8 mm
Width pipe clamp strap	50 mm
Width substructure	332 mm
Length of substructure	270 mm
Load F_x	5,79 kN
Load F_y	5 kN

Product details

Load F_z standing μ 0,2	25 kN
Load F_z standing μ 0,3	16,67 kN
Load F_z hanging μ 0,2	15,15 kN
Load F_z hanging μ 0,3	15,15 kN
Thickness clamp strap	5 mm