

## ■ Sliding sledge C 50 x 5 mm 219 mm EPDM hot-dip galv.

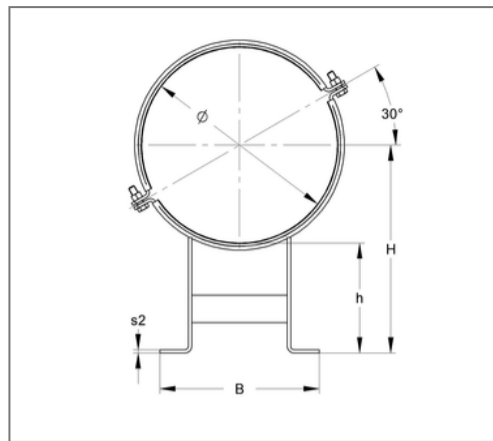
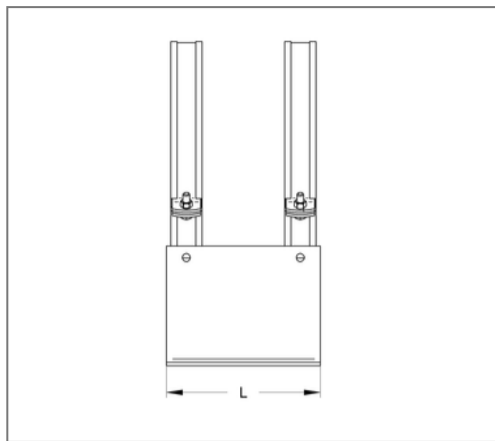

### Commercial details

Part no.	110cfb0219
EAN/GTIN	4250928462374
Packing unit	1 pcs
Quantity unit	pcs
Weight	12,17 kg/pc
Product group	14-108
Price unit	1

### QR code



### Specification

Specification	Double-L-support
Closure	Screw + nut

### Technical data

Material	Steel
Material type	S235
Surface	hot-dip galvanized
Corrosion category	C4 high / C5 medium
Surrounding area	Indoor and outdoor areas
Insulation thickness	6 mm
min. temperature resistance	-35 °C
max. temperature resistance	100 °C
Sound insulation lining	Rubber EPDM
Safety factor	1,54

### Product details

Closure screw	M12
Outer pipe diameter	219 mm
Axis height	310 mm
Material thickness	6 mm
Width pipe clamp strap	50 mm
Width substructure	253 mm
Length of substructure	270 mm
Load $F_x$	3,39 kN
Load $F_y$	5 kN

## Product details

Load $F_z$ standing $\mu$ 0,2	17,05 kN
Load $F_z$ standing $\mu$ 0,3	16,67 kN
Load $F_z$ hanging $\mu$ 0,2	8,52 kN
Load $F_z$ hanging $\mu$ 0,3	8,52 kN
Thickness clamp strap	5 mm