

■ U-bolt 60,3 mm M10 Total height 125 mm

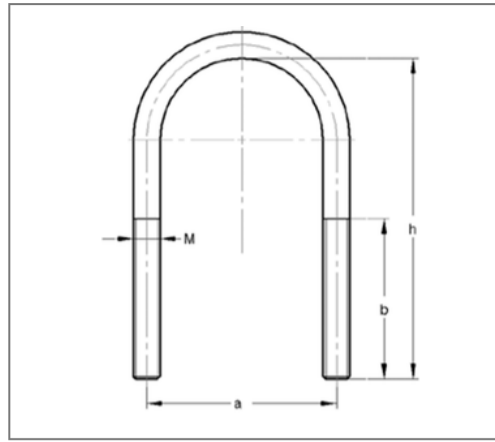

Commercial details

Part no.	050706001
EAN/GTIN	4250928459435
Packing unit	100 pcs
Quantity unit	pcs
Weight	0,154 kg/pc
Product group	01-050
Price unit	1

QR code

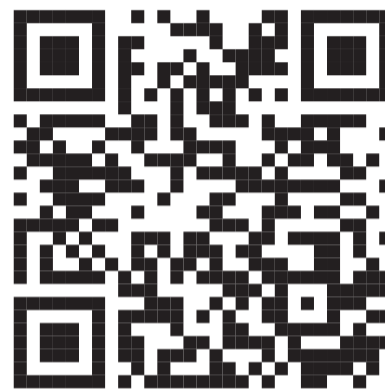

Specification

Application area	For direct installation of piping onto steel structures and suitable for push-through-assembling into profile rails. Suitable for sprinkler and VdS.
------------------	--

Product details

Center distance a	71 mm
Height h	125 mm
Outside pipe diameter inch	val.RohraußendurchmesserZoll.2 inch
Thread M	M10
Length thread b	75 mm
Outer pipe diameter	60,3 mm

Technical data

Material	Steel
Material type	S235
Surface	galvanized
Corrosion category	C2 very high
Surrounding area	Indoor area

Remark

Notice	without nut
--------	-------------