

■ Fixpoint Type B 457,0 mm TPE/EPDM CENTUM® Massive connector

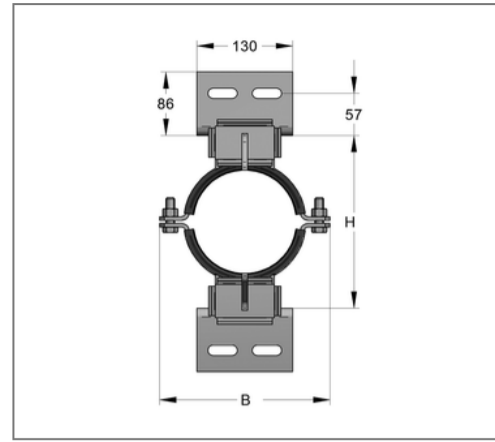
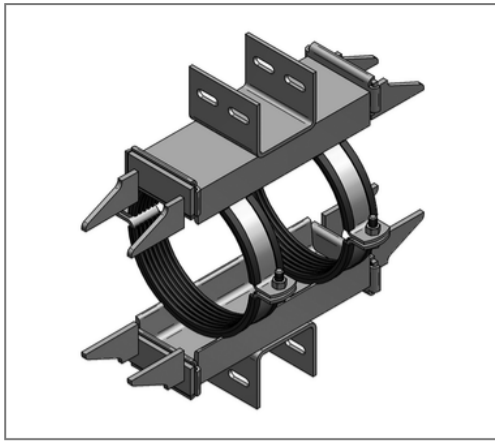

Commercial details

Part no.	9993145
EAN/GTIN	4250928454355
Packing unit	1 pcs
Quantity unit	pcs
Weight	24,48 kg/pc
Product group	03-002
Price unit	1

QR code



Certification



Specification

Application area	Sound-decoupled fixpoint for welding to ferritic steel pipes. With connection possibility to CENTUM® XL 100 square profile.
Number of pipe clamps	2
Specification	CENTUM® Massive connector
Profile steel type	U120
Pipe clamp type	Titan HD

Technical data

Material	Steel
Material type	S235
Surface	galvanized
Corrosion category	C2 very high
Surrounding area	Indoor area
min. temperature resistance	-35 °C
max. temperature resistance	100 °C
Sound insulation lining	TPE/EPDM
Material carrier and clamps	Steel
Material type carrier and clamps	S235JR
Material pressure pieces	Steel
Material type pressure pads	S235JR
Surface carrier and clamps	galvanized
Surface pressure pieces	raw

Product details

Width B	549 mm
Height H	576 mm
Outer pipe diameter	457,0 mm
Measure construction h	79 mm
Width material pipe clamp	50 mm

Remark

Note	Bearing pressure or reactive force depends on weld seam on site (min. 3 mm fillet weld right / left) and CENTUM construction too.
Note	The quality of weld seam has to be proofed.

Product details

Width profile steel	120 mm
Height profile steel	55 mm
Length of pressure piece L2	116 mm
Length of profile steel L1	330 mm
Load F_Y	60 kN
Thickness material pipe clamp	5 mm