

■ Pipe clamp Titan HD 50x5 135 mm without connection unlined

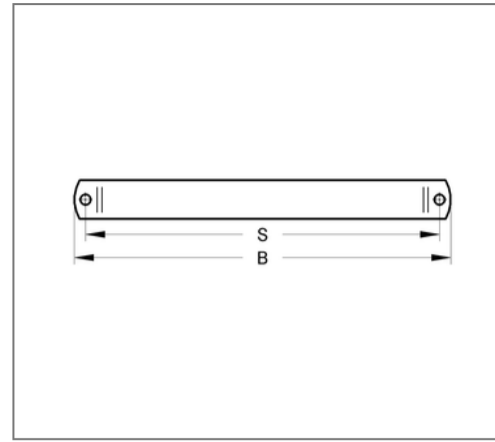
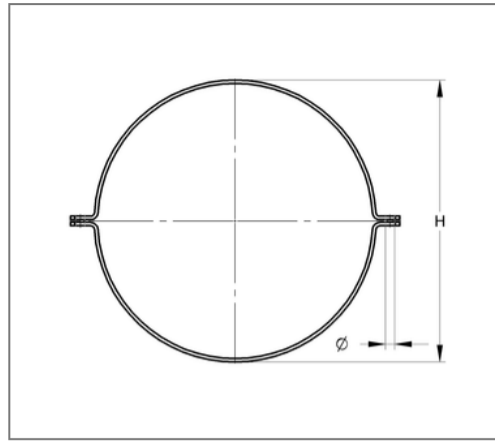
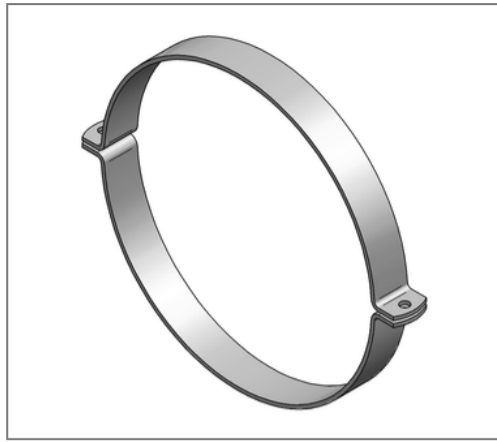

Commercial details

Part no.	0070600
EAN/GTIN	4250928402905
Packing unit	1 pcs
Quantity unit	pcs
Weight	1,06 kg/pc
Product group	01-007
Price unit	100

QR code



Specification

Application	Pipe clamp for fastening pipes in the heavy area
Specification	two-part
Connection	without connection
Closure	Screw coupling

Technical data

Material	Steel
Material type	S235
Surface	galvanized
Sound insulation lining	unlined

Product details

Center distance S	175 mm
Width B	214 mm
Height H	145 mm
Material dimension	50x5 mm
load F_z	6 kN
Outer pipe diameter	135 mm

Remark

Delivery time	5 - 8 working days ex works. Exchange and return are excluded.
Note	not certified acc. to RAL