

■ Turnbuckle open DIN 1480 M12 hot-dip galv.

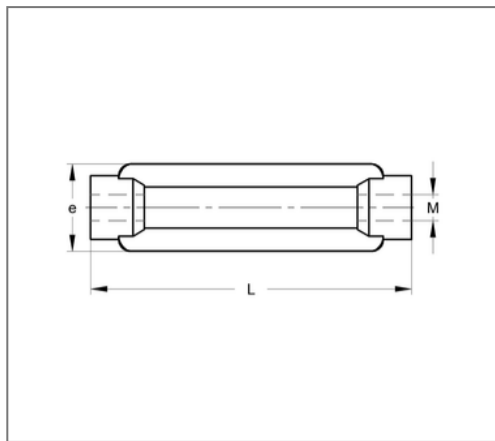
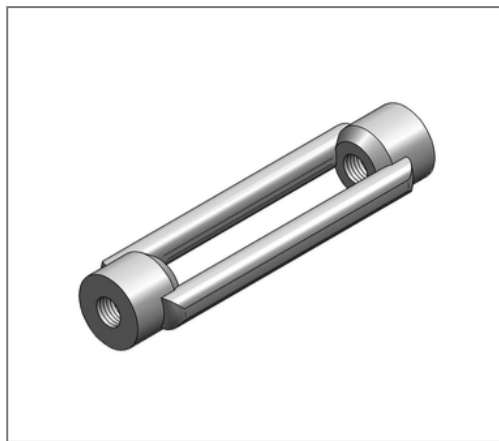

Commercial details

Part no.	1660007452
EAN/GTIN	4250928449573
Packing unit	1 pcs
Quantity unit	pcs
Weight	0,247 kg/pc
Product group	14-166
Price unit	1

QR code



Specification

Application For tensioning tie rods in combination with left-hand right-hand threaded pins.

Technical data

Material	Steel
Surface	hot-dip galvanized
Corrosion category	C4 high / C5 medium
Surrounding area	Indoor and outdoor areas

Product details

Load F_z	9,3 kN
Thread	M12
Length	125 mm
Outer diameter	34 mm
Adjustability	80 mm