

■ Roller bearing double radial-axial 813 - 1350 mm 50 kN 300 mm hot-dip galv.

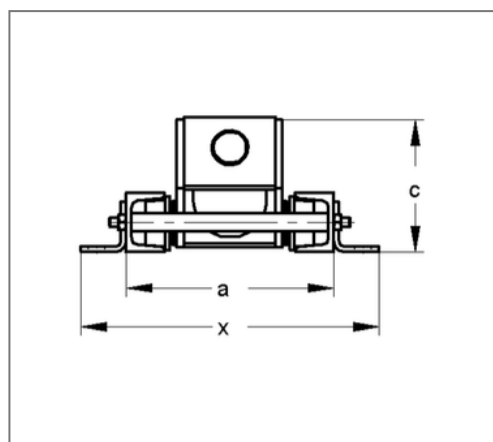
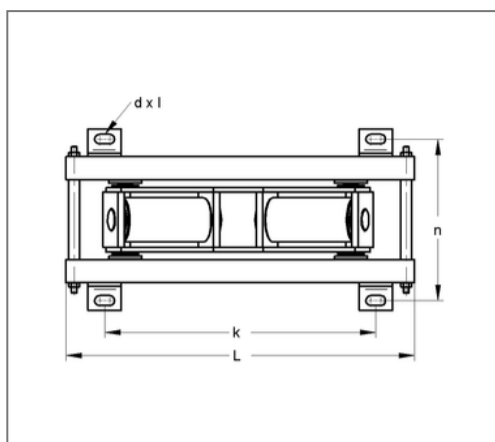
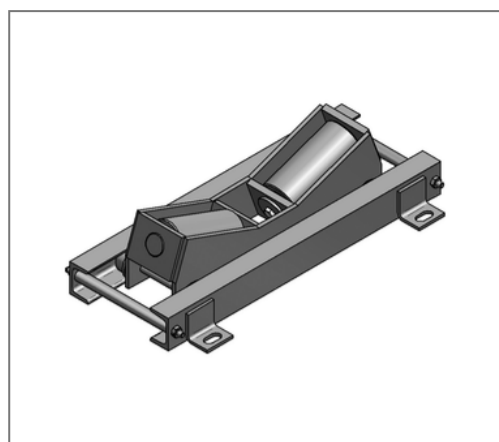

Commercial details

Part no.	150xfc081350
EAN/GTIN	4250928435781
Packing unit	1 pcs
Quantity unit	pcs
Weight	76,77 kg/pc
Product group	14-150
Price unit	1

QR code



Specification

Application roller bearing in double design for supporting area heavy pipelines on insulation-saddle.

Technical data

Material	Steel
Material type	S235
Surface	hot-dip galvanized

Product details

Height	195 mm
load F_z	50 kN
Length	1005 mm
Elongated hole	23x46 mm
Material thickness	12 mm
Hole distance lengthwise	845 mm
Hole distance crosswise	340 mm
Width without lugs	266 mm
min. diameter roller support	813 mm
max. diameter roller support	1350 mm