

■ Roller bearing single axial Roller width 140 mm hot-dip galv.

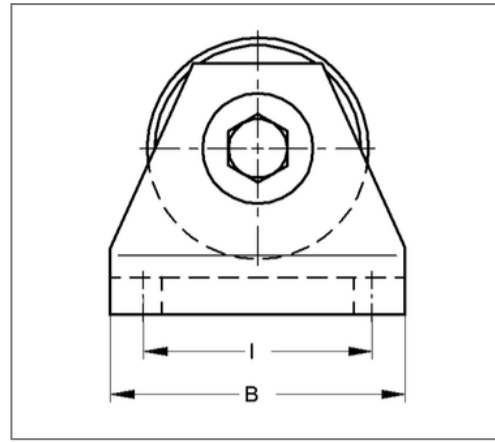
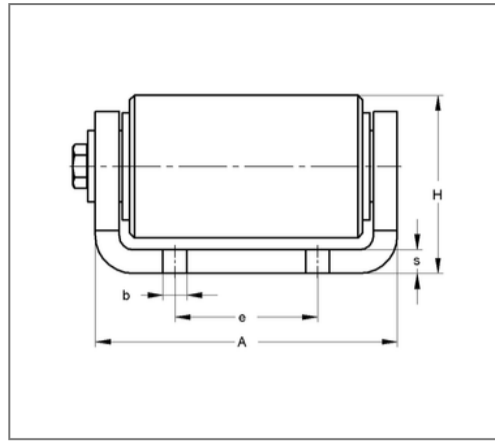
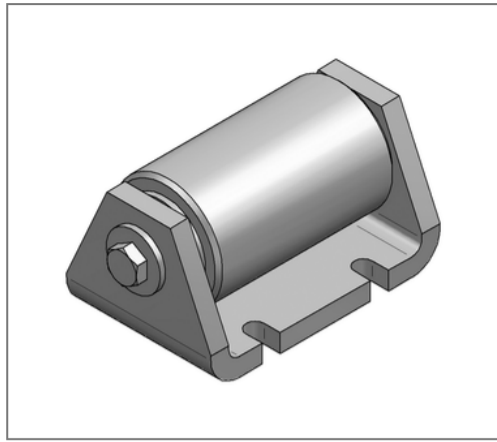

Commercial details

Part no.	150sf100140
EAN/GTIN	4250928435361
Packing unit	1 pcs
Quantity unit	pcs
Weight	5,00 kg/pc
Product group	14-150
Price unit	1

QR code



Specification

Application	Roller bearing in single design for supporting area
	heavy pipelines.

Technical data

Material	Steel
Material type	S235
Surface	hot-dip galvanized
Corrosion category	C4 high / C5 medium
Surrounding area	Indoor and outdoor areas

Product details

Height	90 mm
Load F_z	25 kN
Length	172 mm
Hole- \emptyset	12 mm
Material thickness	10 mm
Safety factor	1,54
Hole distance lengthwise	80 mm
Hole distance crosswise	80 mm
Width without lugs	100 mm