

■ Roller bearing single axial Roller width 100 mm hot-dip galv.

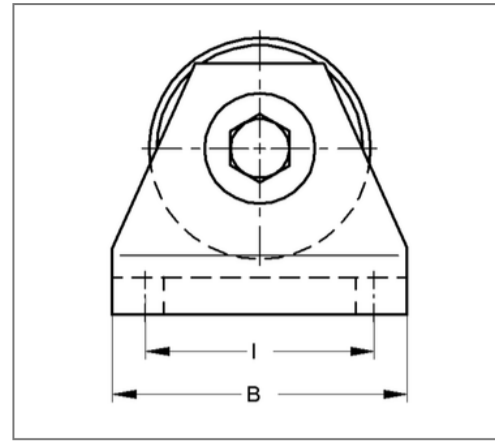
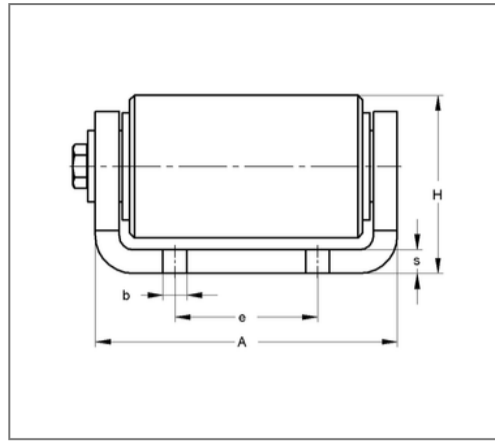
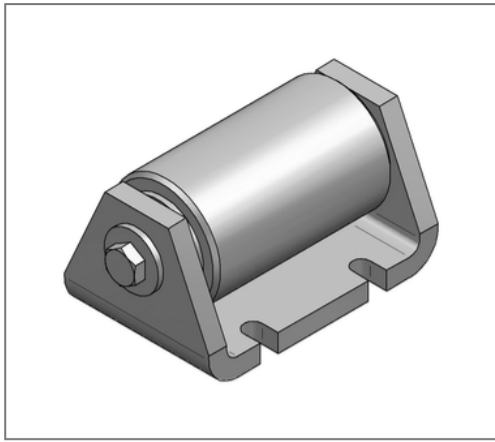

Commercial details

Part no.	150sf080100
EAN/GTIN	4250928435354
Packing unit	1 pcs
Quantity unit	pcs
Weight	3,40 kg/pc
Product group	14-150
Price unit	1

QR code



Specification

Application	Roller bearing in single design for supporting area
	heavy pipelines.

Technical data

Material	Steel
Material type	S235
Surface	hot-dip galvanized
Corrosion category	C4 high / C5 medium
Surrounding area	Indoor and outdoor areas

Product details

Height	75 mm
Load F_z	15 kN
Length	126 mm
Hole- \emptyset	10 mm
Material thickness	10 mm
Safety factor	1,54
Hole distance lengthwise	60 mm
Hole distance crosswise	60 mm
Width without lugs	80 mm