

■ Hexagon nut Steel hot-dip galv. M16 SW 24

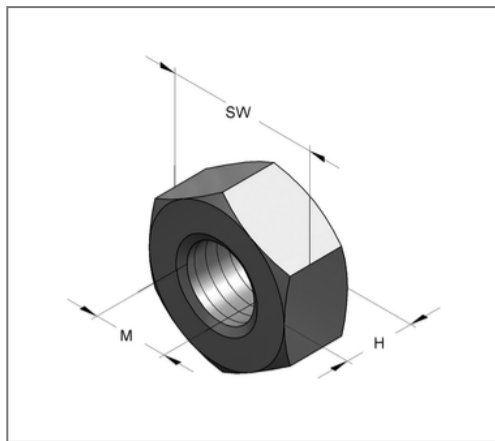
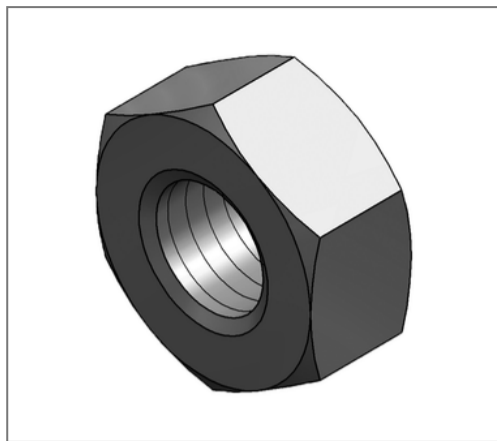

Commercial details

Part no.	4120523/fvz
EAN/GTIN	4250928457165
Packing unit	100 pcs
Quantity unit	pcs
Weight	0,0387 kg/pc
Product group	05-412
Price unit	100

QR code



Certification



Technical data

Material	Steel
Surface	hot-dip galvanized
Corrosion category	C4 high / C5 medium
Surrounding area	Indoor and outdoor areas
Strength class	8
Norm	DIN 934

Product details

Height H	13 mm
Thread M	M16
Wrench size SW	24