

■ Spacer plate CENTUM Clamping claw AF Type 16 P2 Thickness 10 mm for AF M16

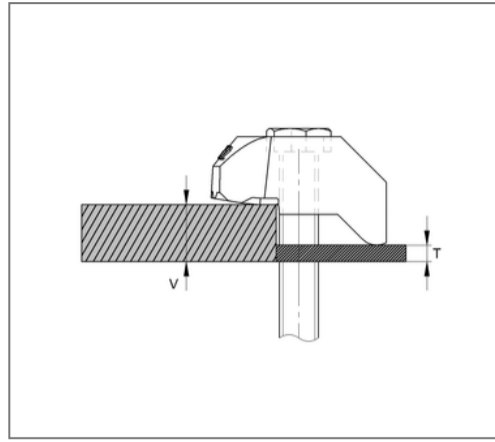
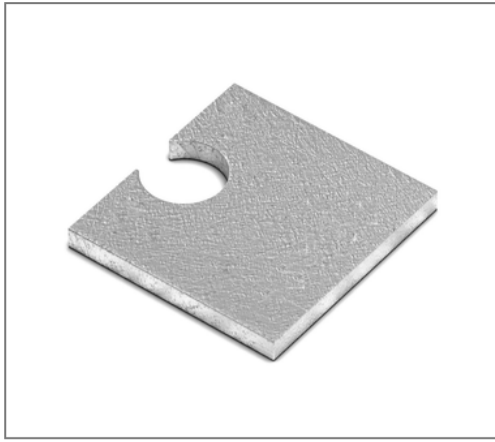

Commercial details

Part no.	0576116
EAN/GTIN	4250928414564
Packing unit	1 pcs
Quantity unit	pcs
Weight	0,200 kg/pc
Product group	14-166
Price unit	1

QR code



Certification



Specification

Application For raising clamping thickness of CENTUM®
area clamping claw type AF.

Technical data

Material	Spherulitic cast iron
Surface	hot-dip galvanized
Corrosion category	C4 high / C5 medium
Surrounding area	Indoor and outdoor areas

Product details

Width	52 mm
Length	50 mm
Thickness T	10 mm
for thread	M16
Type	16 P2

Remark

Delivery time on demand