

■ Console CENTUM XL 100 L= 960 mm hot-dip galv.

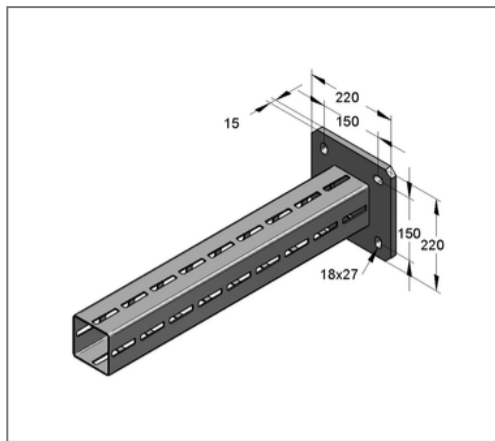
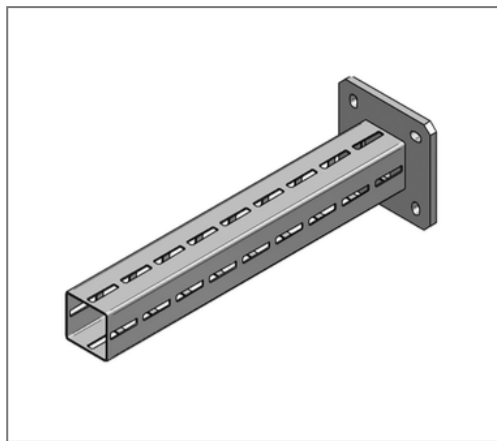

Commercial details

Part no.	1631000960
EAN/GTIN	4250928436788
Packing unit	1 pcs
Quantity unit	pcs
Weight	13,62 kg/pc
Product group	14-163
Price unit	1

QR code



Certification



Specification

Application area Console for the production of cantilever structures for the support of suspended and standing pipe loads.

Technical data

Material	Steel
Surface	hot-dip galvanized
Corrosion category	C4 high / C5 medium
Surrounding area	Indoor and outdoor areas

Product details

Width plate	220 mm
Length plate	220 mm
Hole distance	150 mm
Plate thickness	15 mm
Width profile	100 mm
Profile height	100 mm
Length console L	960 mm
Elongated hole plate	27x18 mm
Load F1	12,13 kN
Load F2	6,06 kN
Load q0	12,63 kN/m
Profile thickness	3 mm