

## ■ Threaded coupling hexagon V2A Fem. thread M16 L= 40 mm

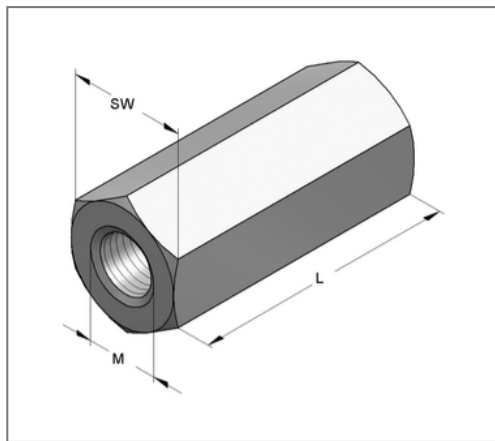
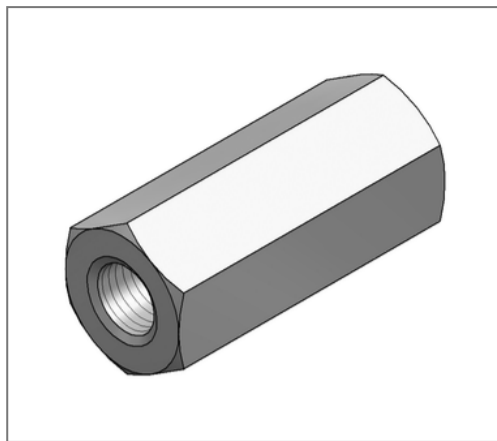

### Commercial details

Part no.	0702844
EAN/GTIN	4250928416261
Packing unit	25 pcs
Quantity unit	pcs
Weight	0,111 kg/pc
Product group	13-048
Price unit	100

### QR code



### Certification



### Technical data

Material	Stainless steel
Material type	V2A
Surrounding area	Indoor and outdoor areas

### Product details

Length L	40 mm
Female thread 1 M	M16
Length female thread 1	40 mm
Wrench size SW	24