

■ Threaded pin DIN 976-1 V2A M10 x 110 mm

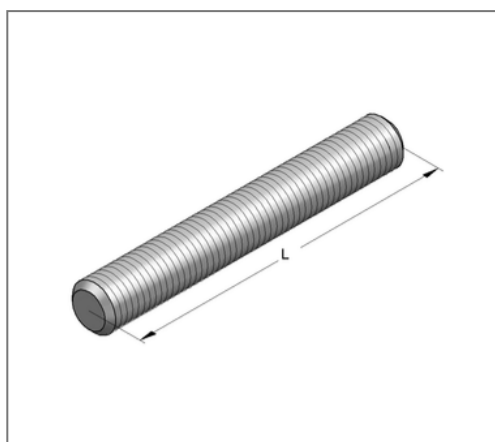
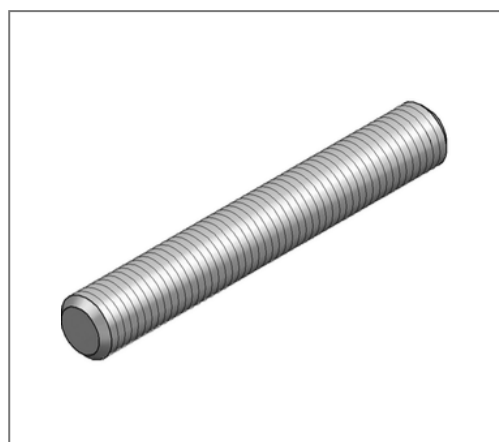

Commercial details

Part no.	0732410
EAN/GTIN	4250928416896
Packing unit	50 pcs
Quantity unit	pcs
Weight	0,0570 kg/pc
Product group	13-048
Price unit	100

QR code



Certification



Technical data

Material	Stainless steel
Material type	V2A
Surrounding area	Indoor and outdoor areas

Product details

Thread	M10
Length L	110 mm
Tension load	24,85 kN